

NATIONAL CODE OF PRACTICE FOR THE PREVENTION OF FALLS IN GENERAL CONSTRUCTION



APRIL 2008



Australian Government
**Australian Safety and
Compensation Council**





ISBN 0 642 32702 5 (Print Version)

© Commonwealth of Australia (Department of Education, Employment and Workplace Relations) 2008

This work is copyright. Apart from any use as permitted under the Copyright Act 1968, no part may be reproduced by any process without prior written permission from the Commonwealth. Requests and inquiries concerning reproduction and rights should be addressed to Commonwealth Copyright Administration, Attorney-General's Department, Robert Garran Offices, National Circuit, Barton ACT 2600 or posted at www.ag.gov.au/cca

ISBN 0 642 32708 4 (Web Version)

© Commonwealth of Australia (Department of Education, Employment and Workplace Relations) 2008

This work is copyright. You may download, display, print and reproduce this material in unaltered form only (retaining this notice) for your personal, non-commercial use or use within your organisation. Apart from any use as permitted under the Copyright Act 1968, all other rights are reserved. Requests and inquiries concerning reproduction and rights should be addressed to Commonwealth Copyright Administration, Attorney-General's Department, Robert Garran Offices, National Circuit, Barton ACT 2600 or posted at www.ag.gov.au/cca



TABLE OF CONTENTS

FOREWORD	5
1. TITLE	7
2. PURPOSE	8
3. SCOPE and APPLICATION	9
4. DUTY HOLDER RESPONSIBILITIES	10
4.1 What does the National Standard require?	10
4.2 Consultation requirements	12
4.3 Thinking ahead: design and planning to prevent falls	13
5. MANAGING RISKS TO PREVENT FALLS	16
5.1 Requirements of the National Standard	16
5.2 Application of physical fall prevention	16
5.3 Identifying fall hazards	16
5.4 Assessing the risk of a fall	17
5.5 Controlling the risks	18
5.6 Other (risk control) considerations	20
6. WORKING AT HEIGHTS OF LESS THAN 2 METRES	22
6.1 Duties	22
6.2 Risk management	22
6.3 Methods of controlling risks	22
6.4 Information, instruction and training	22
6.5 Portable ladders	24
6.6 Trestle scaffolds	25
6.7 Ladder-bracket scaffolds	25



7. WORKING AT HEIGHTS OF 2 METRES AND ABOVE	27
7.1 Duties	27
7.2 Safe Work Method Statements	27
7.3 Application of physical fall prevention measures	28
7.4 Methods of controlling risks for work at height of 2 metres or more	28
7.4.1 Work on the ground	28
7.4.2 Work from a solid construction	28
7.4.3 Passive fall prevention devices	29
7.4.4 Work positioning systems	39
7.4.5 Fall injury minimisation systems	41
7.4.6 Use of ladders	43
7.4.7 Administrative controls	45
8. TRENCHING AND EXCAVATION WORK	47
8.1 Duties	47
8.2 Risk assessment	47
8.3 Control measures	48
9. APPENDICES	49
Appendix 1 : Design considerations	49
Appendix 2 : Safe Work Method Statement template	50
Appendix 3 : Installing safety mesh	54
Appendix 4 : Roof work	57
Appendix 5 : Guarding of holes and openings	61
Appendix 6 : Fall-arrest systems	62
Appendix 7 : Common fall hazards – things to consider	68
Appendix 8 : Scaffolding – safety considerations	70
Appendix 9 : Guardrails – safety considerations	71
Appendix 10 : Publications referenced	72
10. LIST OF FIGURES	73
11. DEFINITIONS	75



FOREWORD

The Australian Safety and Compensation Council (ASCC) leads and coordinates national efforts to prevent workplace deaths, injury and disease in Australia. Through the quality and relevance of the information it provides, the ASCC seeks to influence the awareness and activities of every person and organisation with a role in improving Australia's occupational health and safety performance.

More specifically, the ASCC aims to:

- > support and enhance the efforts of the Australian, state and territory governments to improve the prevention of workplace deaths, injury and disease
- > work in alliances with others to facilitate the development and implementation of better preventative approaches, and
- > ensure the needs of small business are integrated into these approaches.

The National OHS Strategy 2002-2012, released by the Workplace Relations Ministers' Council on 24 May 2002, records a commitment by all Australian governments, the Australian Chamber of Commerce and Industry and the Australian Council of Trade Unions to share the responsibility of ensuring that Australia's performance in work-related health and safety is continuously improved.

The National OHS Strategy sets out five national priorities to achieve short-term and long-term improvements.

The priorities are to:

- > reduce high incidence and high severity risks
- > improve the capacity of business operators and workers to manage occupational health and safety effectively
- > prevent occupational disease more effectively
- > eliminate hazards at the design stage, and
- > strengthen the capacity of government to influence occupational health and safety outcomes.

National standards and codes of practice are declared by the ASCC under section 4 of the *Australian Workplace Safety Standards Act 2005* (Commonwealth), and describe preventive action to avert occupational deaths, injuries and diseases. Most national standards deal with the elimination, reduction or management of specific workplace hazards.

The expectation of the Australian Government and the ASCC is that national standards and codes will be suitable for adoption by the Australian, state and territory governments. Such action will increase uniformity in the regulation of occupational health and safety throughout Australia and contribute to the enhanced efficiency of the Australian economy.

ASCC documents are instruments of an advisory character, except where a law, other than the *Australian Workplace Safety Standards Act 2005*, or an instrument made under such a law, makes them mandatory. The application of any ASCC document in any particular state or territory is the prerogative of that state or territory.



This *National Code of Practice for the Prevention of Falls in General Construction*, referred to in this document as the Code, is part of a package of occupational health and safety material supporting the *National Standard for Construction Work [NOHSC:1016(2005)]* (National Standard). The Code provides practical guidance material and advice on ways to eliminate and minimise the risk of falls from height in general construction work and prescribes circumstances in which the provision of physical fall prevention measures are required, so far as is reasonably practicable.

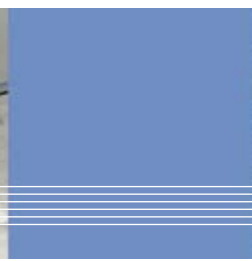
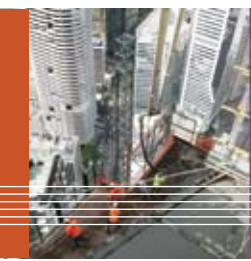

1. TITLE

This document may be cited as the *National Code of Practice for the Prevention of Falls in General Construction*.



2. PURPOSE

This Code provides guidance to persons working in the general construction industry on ways to eliminate or, if that is not possible, minimise the risk of a fall from height.



3. SCOPE AND APPLICATION

The Code provides guidance on adopting a risk management approach to fall prevention for working at heights of less than 2 metres, as well as guidance on risk assessment processes, preparation of Safe Work Method Statements (SWMS) and examples of physical fall prevention measures that are required when working at heights of 2 metres and above, so far as is reasonably practicable.

Everyone who has a duty to prevent people falling while undertaking general construction work should use this Code. This includes employers, workers, self-employed people, architects, engineers, designers, builders, manufacturers, suppliers, health and safety representatives and health and safety committees. The Code can be used to develop specific workplace and industry programs for the control of risks associated with working at height in the Construction industry.

The Code is not intended to apply to work on mobile plant, with the exception of mobile plant specifically mentioned in this Code, or that which is commonly used to perform work at height in the general construction industry.

The Code is not intended to apply to work carried out on minesites, which is covered by mining legislation in the relevant states and territories.

The Code also provides general guidance for civil construction work such as trenching and excavating in so far as they pose a fall hazard. For more specific guidance refer to jurisdictional codes.



4. DUTY HOLDER RESPONSIBILITIES

An important element in the prevention of falls in general construction work is a clear understanding by all parties about who has responsibilities in relation to fall prevention, and how those responsibilities can be met.

4.1 What does the National Standard require?

The National Standard places health and safety responsibilities on clients, designers, persons with control of construction projects or construction works and persons engaged in the actual construction work.

The National Standard covers a range of issues that should be addressed to ensure that those working on construction sites are as safe as possible. These include:

- > consultation between clients, designers, persons with control of work, and workers on providing a safe environment for all work at heights
- > design and planning considerations for working at height
- > fall hazard identification, risk assessment and control
- > taking appropriate steps where there is a risk that a person could fall 2 metres or more, which can include the provision of physical fall prevention measures, so far as is reasonably practicable, and the preparation of a SWMS
- > ensuring that the provision of fall prevention measures does not introduce new risks
- > monitoring the performance of prevention measures
- > the provision of information, instruction and training on safe work at heights
- > providing adequate supervision to ensure that fall prevention is provided and used in accordance with the risk assessment and any applicable SWMS
- > emergency procedures for working at height, and
- > safe access to and egress from work areas where there is a risk of falling.

State and territory requirements

All persons involved in general construction work must comply with the relevant occupational health and safety legislation administered by state and territory OHS Authorities.

What are the duties when working at a height of less than 2 metres?

The National Standard requires that those with a duty to ensure the health and safety of persons undertaking or affected by construction work adopt a risk management approach for the prevention of falls. In situations where persons are working at heights where there is a risk of falling less than 2 metres, the standard risk management model of identifying fall hazards, assessing the risk of a fall occurring, and controlling the risks should be adopted.

Information on working at heights of less than 2 metres can be found at section 6 of this Code.



What are the duties where work is being done at 2 metres or more?

High-risk construction work includes work at height where there is a risk that a person could fall 2 metres or more.

Persons in control of a construction project or construction work where there is a risk that someone undertaking construction work could fall 2 metres or more must ensure that:

- > hazards, including hazards other than fall hazards, have been identified
- > where reasonably practicable, physical fall prevention is provided
- > other hazards have been controlled, and
- > after a risk assessment has identified what controls are needed, a SWMS detailing the control measures to be used, is developed for the work.

More information about hazard identification and the risk assessment process can be found in sections 5 and 6 of this Code.

Who has a duty to prevent a fall?

The National Standard identifies a number of people who have a duty to protect workers and others working near the site from a fall.

Generally:

Clients have a duty to consult with designers and builders to ensure, so far as is reasonably practicable, that the structure to be built is designed and constructed so that workers, and any other persons on the construction site, are protected from hazards such as a fall from height. Clients also have a duty to consult with the person with control of a construction project to ensure that other people who may be affected by the construction work undertaken on the site are not put at risk by those work activities.

Designers have a duty to ensure, to the extent that they have control over the design, that fall hazards arising from the design are identified and, where possible, eliminated by design modification. Hazards that remain should be identified in a written report to the client.

A person with control of a construction project is responsible for the health and safety of any person who may be affected by the construction work. A person with control of a 'construction project' can include people such as principal, head or main contractors, builders, employers or persons with management control. This means that the person with control of a construction project has a duty to ensure, so far as is reasonably practicable, that persons engaged to undertake the work, and any other person affected by the work, are protected from the risk of a fall from height. The person with control of the project must ensure that fall prevention is set up to cover all workers on site, whether the fall prevention is provided directly by the person with control of the project, or by individual subcontractors.

For example, if a principal contractor was aware that subcontractors would be working at height on a task such as installing a roof where there is a risk of a fall, that person would need to either make sure that appropriate fall prevention was provided, or ensure that the subcontractors performing the work were using appropriate fall prevention measures.

Persons with control of construction work must take steps, to the extent that they have control over the work, to ensure their own and their workers' safety and health at work and, so far as is reasonably



practicable, ensure their work does not increase the risk of a fall for others. A person with control of 'construction work' can include principal, main and sub-contractors, employers and self-employed persons.

Persons with control of a construction project and construction work should provide adequate supervision to ensure that workers are working in accordance with established safe work procedures, are not exposed to the risk of falling and are undertaking their work in accordance with the information, instruction and training they have received.

Additional supervision by a competent person should be provided where workers are undergoing training or are unfamiliar with the working environment.

Workers must ensure, as far as they are able, that their work does not put themselves or others at risk and that they undertake work at height in accordance with the information, instruction and training with which they have been provided.

4.2 Consultation requirements

Some communication considerations

Good communication is vital in helping make construction sites safer places to work. This means that the information a person may need to work safely and the best way of providing that information need to be examined. The level of training, experience and general language skills are all things that should be considered when communicating with a range of people on a construction site. For example, does the way the information is provided need to be altered because the person does not use English as their first language?

The National Standard requires consultation between:

- > the client and designer
- > the client and person with control of a construction project, and
- > persons with control of either a construction project or construction work and those performing the work (e.g. subcontractors, self-employed persons, and employees).

Clients:

As a client, when commissioning the design for a new building or structure (or an extension or alteration to an existing building or structure), you should consult with the designer and the person you appoint to oversee the construction project, e.g. the builder, to ensure that fall prevention measures for workers are fully considered.

Persons with control:

Persons with control of a construction project and/or construction work (this could include self-employed people and subcontractors), must ensure there are arrangements in place for all persons engaged to undertake the work so that they are consulted on work-related matters that may affect their health and safety.



Persons with control should consult with construction workers directly. The experience and knowledge held by subcontractors and workers can be invaluable in identifying fall hazards and controlling fall risks. Direct consultation on controlling fall risks will increase workers' commitment to the risk management process.

Employers:

Employers may also be required by law to consult with health and safety representatives and their employees on health and safety matters.

Subcontractors and self-employed:

Subcontractors and self-employed persons should consult with the person with control of a construction project to ensure that work plans and the application of fall control measures are compatible and consistent across the site.

4.3 Thinking ahead: design and planning to prevent falls

Design considerations

Fall risks should be eliminated, or otherwise minimised, at the design stage.

Designers of buildings and structures have a duty to ensure that the hazards arising from a design are identified before commencement of construction work. To the extent that they have control over the design, the designer should modify the design to eliminate those hazards or, as far as is reasonably practicable, minimise the risks they pose.

Designers should also report to the client, in writing, on the health and safety aspects of the design. The designer's report should include, for example, the details of any hazardous structural features or material, procedures or practices that remain in the design, and whether these hazards, or the risks arising from them, could be eliminated by design modifications. If any risks of falls from heights remain in the design, information should be included with the design documentation to alert others to these risks. The provision of clear information about safety issues is a key aspect of ensuring a proper, adequate and suitable design.

These duties apply equally to any person involved in designing the repair, modification, renovation, or maintenance of an existing structure.

At the design stage, designers should:

- > identify hazards associated with the design of a building or structure that may arise while it is being constructed, repaired, cleaned, maintained or demolished and to which a person at the workplace is likely to be exposed
- > assess the risk of injury or harm to a person from any hazards arising from the design, and
- > where reasonably practicable eliminate, or otherwise minimise risks arising from the design by design modification.



Planning considerations

Careful project planning can help reduce the risks of working at height.

Planning for building maintenance

During the planning stage, consideration should be given to the methods by which maintenance, repairs or cleaning will be undertaken on a building or structure.

Consideration of future maintenance requirements at the early design stage will avoid the possibility of unsafe work practices occurring during routine maintenance. Sloping building exteriors and decline windows require priority consideration to ensure maintenance and cleaning can be carried out safely.

Planning by the person with control of a construction project

Persons with control of a construction project should ensure that:

- > regular consultation occurs with all parties involved in the project
- > plans, specifications and any other information that will assist in performing the work safely have been provided to any subcontractors
- > the subcontractors understand the correct sequence of critical operations relevant to their work to be carried out on site
- > the subcontractors are competent to perform the work safely
- > the risks of falling have been identified and documented in a risk assessment
- > the identified hazards are eliminated, or where these hazards cannot be eliminated, suitable control measures are put in place
- > where work at or above a height of 2 metres is being performed and there is a risk of falling, physical fall prevention measures are implemented so far as is reasonably practicable and SWMSs are prepared
- > adequate training is provided to all persons undertaking work on site
- > the hazards and control measures are monitored and reviewed to ensure continued effectiveness
- > there is sufficient supervision in place to monitor the subcontractors' safety performance, and
- > jobs have been sequenced so that different trades will not interfere with each other's work and no-one will be working above or below anyone else at the same time without adequate protection.



Planning the site layout

When planning the site layout, the following factors should be considered:

- > the preparation of firm, level surfaces below work areas for the support of plant and equipment, such as scissor lifts or mobile scaffolds
- > the site and condition of access roads to enable plant to place material in and pick it up from the most favourable positions, thereby reducing, for example, the need for manual handling at height
- > safe access to and egress from work areas and amenities, including the provision and placement of stairways, ladders, catwalks, guardrails and barriers, and
- > the need for adequate means of escape and rescue in the event of an emergency.

Planning by subcontractors

The following may assist subcontractors in planning their work. Before commencing work on a job, ensure that:

- > individual work plans are consistent with the work plan of the person with control over the project
- > all information needed to do the job safely has been obtained
- > a documented risk assessment for the work to be undertaken has been prepared and there is access to the document
- > where work is undertaken at a height of 2 metres or more and there is a risk that a person undertaking that work could fall, physical fall prevention measures have been provided so far as is reasonably practicable and a SWMS documenting relevant fall prevention controls has been prepared for that work
- > work plans include consultations with and information for workers
- > controls are in place and safe work procedures have been established
- > employees have received adequate training and instruction in the use of the agreed controls and safe work procedures, and
- > there is adequate supervision to ensure that instructions, safe systems of work, and SWMSs are being followed.

Planning for emergencies

Persons with control of a construction project should ensure that whenever and wherever there is a risk of a fall from a height, emergency procedures and facilities, including first aid, are established and provided.

In developing emergency procedures, the different types of emergency and rescue scenarios that might arise should be considered. Information from the risk assessments will help in this task.

If a project is to be carried out in a remote location beyond the normal communication networks, procedures should be developed that take account of this situation.

Where appropriate, specific emergency exits, routes and plans should be displayed on the construction site, and where indicated by the risk assessment, emergency evacuation procedures should be practised at regular intervals. Any difficulties with these procedures should be identified and resolved.



5. MANAGING RISKS TO PREVENT FALLS

5.1 Requirements of the National Standard

The National Standard requires persons with control of a construction project and construction work to ensure workers are not exposed to fall hazards by following a risk management process. This involves the following steps:

- > **identifying** fall hazards
- > **assessing** the risk of harm to a person associated with each hazard, and
- > **controlling** the risks.

Once control measures have been implemented, they should be subsequently **monitored and reviewed** for their effectiveness.

This risk management process should be undertaken in consultation with workers and where appropriate their health and safety representatives. Their experience and knowledge will help to identify fall hazards and control measures.

5.2 Application of physical fall prevention

Depending on the circumstances, serious injury or death can result from a fall from any height. However, the likelihood of serious injury or death increases with the height from which a person falls.

When work cannot be undertaken on the ground or from solid construction, this Code requires that in so far as is reasonably practicable, physical fall prevention measures are used for the protection of persons undertaking any construction work where there is a risk that they may fall 2 metres or more.

5.3 Identifying fall hazards

Before work commences, all physical locations and tasks that may present the risk of a fall need to be identified. This includes access to the areas where tasks are to be performed. Each task needs to be examined to determine whether there is a risk of falling and how that risk can be eliminated or minimised. In particular, tasks that need particular attention are those carried out:

- > on any structure or plant being constructed or installed, demolished or dismantled, inspected, tested, maintained, repaired or cleaned
- > on a fragile surface (for example cement sheeting roofs, rusty metal roofs, fibreglass sheeting roofs and skylights)
- > on a potentially unstable surface (for example areas where there is potential for ground collapse, including poorly backfilled or compacted ground, or unstable areas such as on top of stacks of building materials, timber pallets or bricks)
- > using equipment to work at the elevated level (for example when using scaffolds, elevating work platforms (EWPs) or portable ladders)



- > on a sloping or slippery surface where it is difficult for people to maintain their balance (for example on glazed tiles)
- > near an unprotected open edge (for example near perimeters without guardrails, or incomplete stairwells), and
- > near a hole, shaft or pit into which a worker could fall (for example trenches, pile holes or service pits).

For further information see Appendix 7: 'Common fall hazards – things to consider'.

5.4 Assessing the risk of a fall

If a task involving a fall hazard has been identified, the risk of a fall should be assessed by determining:

- > the likelihood of a fall and risk of harm to a person occurring, and
- > the extent of harm or injury that a person could receive in the event of a fall.

This assessment is a useful way of determining where the greatest risk is, and therefore which hazards need to be eliminated or controlled first.

The ultimate effectiveness of any risk assessment is dependant on the quality of the information available. Therefore, it is important that persons carrying out risk assessments have the necessary information, knowledge and experience of that work environment and work process.

In carrying out a risk assessment, it is helpful to break down each activity or process into a series of parts or smaller tasks and assess each one separately.

If the risk assessment is for construction work being undertaken at a height of 2 metres or more and there is a risk of falling, physical fall prevention measures should be provided so far as is reasonably practicable. A SWMS should be used to document why a particular control has been used and a more detailed SWMS would be required if it is not reasonably practicable to use physical fall prevention measures.

In addition to work being undertaken at a height of 2 metres or more where there is a risk of falling, the National Standard sets out that a SWMS must also be prepared for any other construction work that meets the definition of 'high-risk construction work' (e.g. construction work involving excavation to a depth greater than 1.5 metres).

A SWMS should also be used when work is being undertaken at a height of less than 2 metres if the risk assessment identifies a need for control measures to be used.

Tips for doing hazard identification and risk assessments

Ways to assess the risk arising from each identified hazard include:

- > looking at similar workplaces or processes
- > looking at the workplace's previous incident and injury reports and data for falls
- > consulting with health and safety representatives and other employees
- > looking at the way tasks/jobs are performed
- > looking at the way work is organised



- > determining the size and layout of the workplace
- > assessing the number and movement of all people at the workplace
- > determining the type of operation to be performed
- > identifying the type of machinery/plant to be used
- > assessing the adequacy of inspection and maintenance processes
- > examining the way all material and substances are stored and handled
- > assessing what knowledge and training is needed to perform tasks safely and the adequacy of current knowledge and training, and
- > examining the adequacy of procedures for all potential emergency situations (e.g: accidents and rescues).

Can the same risk assessment be used for more than one task?

If similar tasks or processes are undertaken in a number of different work areas or workplaces, only a single risk assessment may be required.

A single, or generic, risk assessment will only be appropriate if the hazards and risks for the work areas being covered by the assessment are the same or similar.

For example, if a generic assessment is undertaken by an industry association as a model to be used by a number of different employers with essentially identical workplaces, the person responsible for completing the risk assessment at each workplace is responsible for ensuring that the generic assessment is valid for their workplace.

As with risk assessments generally, workers and their health and safety representatives should be consulted when carrying out generic risk assessments.

5.5 Controlling the risks

If the risk assessment has identified that there is a risk that a fall may occur, measures need to be put in place to control the risk. In general, the results of the risk assessment and the controls are documented in a SWMS. SWMSs are discussed in section 7.2 of this Code, and an example is provided at Appendix 1.

The primary duty is to eliminate the risk. If this is not reasonably practicable, the risk must then be reduced to the minimum level possible, so far as is reasonably practicable. To do this, there is a preferred order (or hierarchy) of risk control measures ranging from the most effective to the least effective, that must be applied.

Hierarchy of control measures

The first priority is always to **eliminate** the risk of a fall. In other words, ensure a fall from height cannot occur. Ways to do this include designing out the risk, or working on the ground or from a solid construction. These are Level 1 controls.



If (and only if) elimination of the fall risk is not reasonably practicable through the application of a Level 1 control, the risk should be **minimised** through the application of control measures lower down in the hierarchy; that is, Level 2 to Level 5 controls (see below: Hierarchy of control).

Only where it is not reasonably practicable to use a higher order control measure may a control at the next lower level be used. Where it is reasonably practicable to undertake part of a task using a higher order control, that control must be used to the extent possible. Where a risk of a fall remains, then the next level of controls must be applied wherever reasonably practicable.

In cases where work is performed at 2 metres or above and physical fall prevention measures are not able to be used because it is not reasonably practicable, it should be documented why physical fall prevention measures were not able to be used.

Which control do I choose?

The hierarchy of control is a tool to help people working in the construction industry choose a control that provides the highest level of safety possible in the circumstances.

Hierarchy of control

The hierarchy of control measures are:

Level 1: Undertake the work **on the ground** or from **a solid construction** (see sections 7.4.1 and 7.4.2).

Level 2: Undertake the work using a **passive fall prevention device** (see section 7.4.3).

These include:

scaffolds	perimeter screens
step platforms	perimeter guardrailing
EWPs	guardrailing edges of roofs
mast climbing work platforms	protection for trenching works
work boxes	safety mesh
purlin trolleys	

Level 3: Undertake the work using a **work positioning system** (see section 7.4.4).

These include:

- > travel restraint systems
- > industrial rope access systems

Level 4: Undertake the work using a fall injury minimisation system (see section 7.4.5).

These include:

- > catch platforms
- > fall-arrest systems



After considering all of the above, if no reasonably practicable control measure has been identified, a Level 5 control may be used.

Level 5: Undertake the work from **ladders** (see section 7.4.6), or implement an administrative control (see section 7.4.7).

5.6 Other (risk control) considerations

Make sure control measures are safe and don't introduce new risks

When selecting the most practical control measure, any non-fall risks associated with those measures must also be considered. Non-fall hazards could include electrical hazards, such as contact with overhead and temporary electrical cabling, and crushing and entanglement from plant such as EWP.

Make sure that the control method that is selected does not expose those installing, erecting or removing it (such as scaffolders) to a greater risk than the one it is designed to control.

If plant or equipment is used to control the risk, it must be “fit for purpose”, that is, it must be designed and constructed for the task and the working environment.

Personal protective equipment

Personal protective equipment (PPE), such as safety boots, gloves and hard-hats provide additional protection when used in conjunction with fall prevention. However, they should not be used as the only control measure.

Operator's skill

The hierarchy generally gives preference to control measures which require the lowest level of skill to operate and maintain. For example, a perimeter guardrail, which is a passive fall prevention device that requires no operator skill (a Level 2 control), should be used in preference to another Level 2 control such as an EWP, which requires a higher level of operator skill.

In other words, where two controls provide an equal measure of protection against falls, the one that requires the least skill to use should be chosen.

Monitoring and review of control measures

Implementing a fall control measure is not the end of the risk management process. Control measures must be monitored and reviewed to ensure that they continue to control the risks they were established for.

Physical fall prevention measures should be monitored regularly to make sure that workers are using them properly. Where an alteration of specific plant or fall prevention measure is to be undertaken, the person with control of the work should make sure that the integrity of the system is maintained and that clear arrangements to this effect are in place with subcontractors.



Each person with control of a construction project or work should ensure that:

- > a planned program of inspections and maintenance is in place
- > a review is undertaken each time the work environment changes, and
- > the process for hazard identification, risk assessment and control is regularly reviewed to ensure it is effective.

In determining the frequency of the monitoring and review process, consideration should be given to:

- > the level of risk (high-risk construction work requires more frequent assessment), and
- > the type of work practice or plant involved.

Information, instruction and training

Information, instruction and training concerning the fall hazards, risks and control measures identified during the risk management process should be provided to those undertaking the construction work.

It should help them to understand:

- > the fall hazards to which they are exposed
- > the risk of injury associated with the task
- > why control measures are needed and how to use them properly, and
- > what action to take if there is an incident.

(For further information see Appendix 7: 'Common fall hazards – things to consider').

The amount and type of information, instruction and training required will depend on the severity of the hazard and the risk involved. It will also depend on the level of skill required to operate or use the control measure. Tasks involving complex work procedures or control measures will require more comprehensive training and the requirements of the respective state or territory should be referred to for certification of scaffolders, riggers, doggers and operators of EWP's.

All information, instruction and training should be provided in a form that can be understood by all workers. This may include providing information in languages other than English.

While training is important, it is not a substitute for effective control of a risk of a fall from height.



6. WORKING AT HEIGHTS OF LESS THAN 2 METRES

A fall from almost any height can result in serious injury or death. It is possible that a number of factors can combine to create a dangerous situation. This possibility makes doing a hazard identification and risk assessment process very important for work at any height.

6.1 Duties

The National Standard places responsibilities on various persons involved in construction work to manage safety on construction sites. Persons with control of a construction project or construction work have a duty to ensure, so far as is reasonably practicable, that persons engaged in, or any other persons affected by the construction work, are protected from the risk of a fall from any height.

Persons with control must take steps, to the extent that they have control over the work, to ensure their own, and their workers, safety and health. Workers must also ensure that their work does not put others at risk and that they undertake work at height in accordance with the information, instruction and training that they have been provided. In other words, this means that the risks of working at heights of less than 2 metres must be assessed and appropriately controlled.

6.2 Risk management

In situations where persons are working at heights of less than 2 metres, the standard risk management model of identifying fall hazards, assessing the risk of a fall occurring, and controlling the risks should be adopted.

Assessing the risks of these potential falls does not need to be complicated. In most cases one can simply:

- > look for the hazards
- > decide who might be harmed and how
- > if a risk exists, consider ways of doing the task more safely, and
- > take action to eliminate the risk; if it is not reasonably practicable to do so, then reduce the risk.

However, persons should use physical fall prevention measures and a SWMS for the work if the risk assessment identifies the need for such measures to be used.

6.3 Methods of controlling risks

A number of the more common tasks associated with falls from less than 2 metres are illustrated at the end of this section, together with methods used to control the risks associated with these hazards.

6.4 Information, instruction and training

Under the National Standard, a person in control of a construction project must ensure that any information, instruction and training relating to the hazards, risks and control measures identified in the

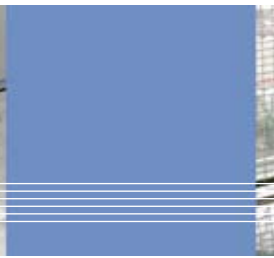

risk management process for working at heights (of less than 2 metres) are provided to those engaged to do the construction work.

The amount and type of information, instruction and training that needs to be provided will depend on the risk involved. The complexity of the work procedures and the type of physical fall prevention measures adopted should also be taken into account.

Hazard: Worker using stilts

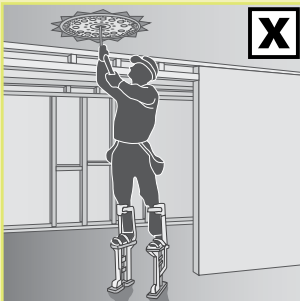

The use of stilts raises a worker's centre of gravity, making the worker much more unstable and prone to tripping, overbalancing or falling through openings in floors or walls. Guardrails are usually not designed for people on stilts, and will not protect the user from falling. Workers sometimes use an unstable support, such as a stepladder to put on stilts, exposing themselves to the hazard of falling.

Figure 1: Hazard – plasterer's stilts.

Solution: Provide a splithead trestle scaffold

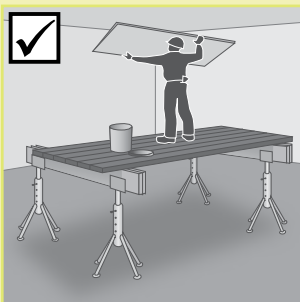

Splithead trestle scaffolds are quick and easy to erect and can be configured in a variety of ways to suit the particular job. They are particularly useful for light and medium duty activities such as plastering, painting and general fit-out and finishing.

Figure 2: A splithead trestle scaffold.



Hazard: Performing a task from a stepladder

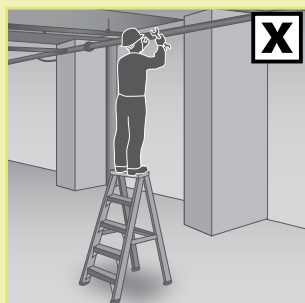

Most ladder-related injuries occur as a result of falls from low heights. Sideways tipping is the cause of most stepladder injuries, and this risk increases as the worker ascends the ladder. In this case, the worker is working above the second tread from the top of the ladder and is at extreme risk of falling. The worker is often working alone and does not have anyone to hold the stepladder to stabilise it.

Figure 3: Hazard – standing above second tread of stepladder.

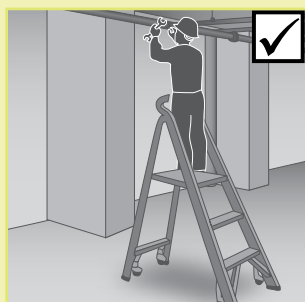

A commercially available step platform provides a safer alternative to a stepladder – especially where the task involves extended periods working at height or restricted vision (such as welding or other hot work). The step platform is extremely stable and provides a much larger work surface than the stepladder. Some models are collapsible.

Figure 4: A step platform provides a stable work surface.

Figures one, two, three and four courtesy of WorkSafe Victoria, Code of Practice – No. 28 – Prevention of Falls in General Construction, 31 March 2004.¹

6.5 Portable ladders

For general advice on the selection and maintenance of ladders refer to section 7.4.6 of this Code.

People using ladders should not:

- > handle or use ladders where it is possible for the worker or the ladder to make contact with powerlines
- > use metal or metal reinforced ladders when working on live electrical installations
- > set up the ladder in places, such as driveways and doorways, where a person or vehicle could hit it. If necessary, erect a barrier or lock the door shut
- > use a stepladder near the edge of an open floor, penetration, or on scaffolding to gain extra height
- > over-reach (the worker's belt buckle should remain within the ladder stiles throughout the work)

¹ For further information and future updates, please access www.worksafe.vic.gov.au



- > use any power (air, hydraulic, electric or battery) equipment or tool specifically designed to be operated with two hands and which may require the operator to brace themselves against the high level of torque exerted by the tool
- > carry out work such as arc welding or oxy cutting unless step platforms or other temporary work platforms are not feasible and the task is of short duration and a safe work procedure is followed
- > use tools requiring the use of both hands and dynamic movement such as axes and crowbars
- > use tools which require a high degree of leverage type force which, if released, may cause the user to over balance or fall from the ladder, such as stillsons or pinch bars
- > work over other people, and
- > allow anyone else to be on the ladder at the same time.

Except where additional and appropriate fall protection equipment is used in conjunction with the ladder, any person using a ladder should not:

- > face away from the ladder when going up or down, or when working from it
- > stand on a rung closer than 900mm to the top of a single or extension ladder, and
- > stand higher than the second tread below the top plate of any stepladder

A ladder must be set up on a surface that is solid, stable and secure. It must also be set up to prevent it from slipping.

6.6 Trestle scaffolds

When adjusting the height of a trestle scaffold, make sure that only the purpose-designed pins are used. Do not use nails or pieces of reinforcing bar.

Further guidance on trestle scaffolds is provided in AS/NZS 4576 or most recent equivalent.

6.7 Ladder-bracket scaffolds

Ladder-bracket scaffolds are constructed from single or extension ladders with brackets to support scaffold planks. Use only for very minor tasks where the worker cannot fall more than 2 metres.

If the platform is at a height of 2 metres, the scaffolds should be used in conjunction with physical fall prevention measures so far as is reasonably practicable.

When using ladder-bracket scaffolds, observe the following:

- > only use industrial grade single or extension ladders
- > pitch the ladders at a horizontal to vertical slope ratio of 1:4
- > make sure the ladders are firmly footed on a hard level surface
- > secure the ladders against movement
- > keep the horizontal distance between brackets to 2.4 metres or less
- > make sure the planks are genuine scaffold planks in good condition



- > provide barricades or other suitable controls to prevent traffic damage
- > no more than one person should be supported in any bay of the scaffold, and
- > do not stack materials on the working platform.

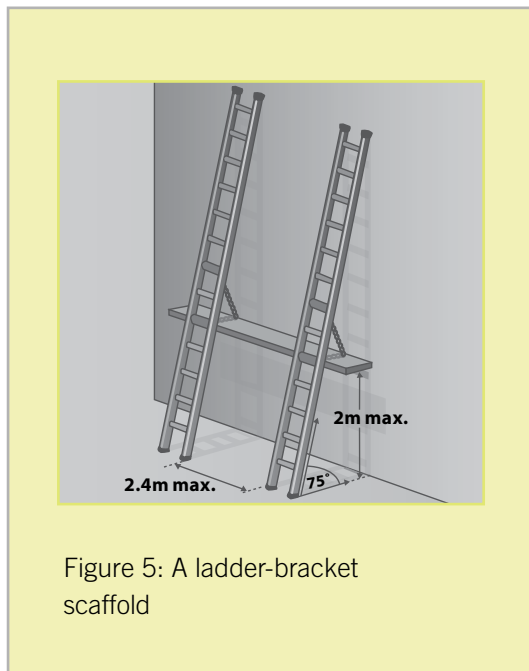

Figure 5: A ladder-bracket scaffold

Courtesy of WorkSafe Victoria, Code of Practice – No. 28 – Prevention of Falls in General Construction, 31 March 2004.²

² For further information and future updates, please access www.worksafe.vic.gov.au



7. WORKING AT HEIGHTS OF 2 METRES AND ABOVE

Depending on the circumstances, serious injury or death can result from a fall from any height. However, the likelihood of serious injury or death increases with the height from which a person falls.

7.1 Duties

The National Standard for Construction Work requires those with a duty to ensure the health and safety of persons undertaking or affected by construction work to adopt a risk management approach to the prevention of falls. The fundamental principles of the risk management process are detailed in section 5.

The National Standard also requires a SWMS to be developed for all high-risk construction work. High-risk construction work includes work at height where there is a risk that a person could fall 2 metres or more (an example of a SWMS can be found at Appendix 2).

Persons in control of a construction project or construction work where there is a risk that someone undertaking construction work could fall 2 metres or more, must ensure that physical fall prevention measures are provided so far as is reasonably practicable, and that a SWMS is developed for that work, which is kept up to date and complied with. If it is not reasonably practicable to provide physical fall protection, persons in control will need to document why they have not been able to use it and document how they have reduced the risks to the lowest possible level by the use of other means in accordance with the hierarchy of control.

7.2 Safe Work Method Statements

Generally speaking, a SWMS is used to document the results of a risk assessment process carried out for a particular task or work activity and identifies the controls to be implemented.

A SWMS is a statement that:

- a. identifies a work activity assessed as having a safety risk or risks
- b. states the safety risk or risks
- c. describes the control measures that will be applied to the work activity
- d. describes how safety measures will be implemented, and
- e. includes a description of the equipment used in the work, the qualifications of the personnel doing the work and the training required to do the work safely.

The statement is designed to be developed after or in conjunction with a risk assessment. The SWMS must then be completed before all reasonable risk control measures are put into place and prior to work commencing.

A SWMS may be a standardised form produced by an association, employer or government agency. See Appendix 2 for guidance on the development and use of a SWMS.

A SWMS used for a particular task on a construction project should reflect the specific safety requirements of the work being undertaken on that project.



7.3 Application of physical fall prevention measures

When work cannot be undertaken on the ground or from a solid construction, this Code requires that physical fall prevention measures are used, so far as is reasonably practicable, for the protection of persons undertaking any construction work where there is a risk that they may fall 2 metres or more.

Physical fall prevention includes those measures listed as Level 2, 3, and 4 controls (see sections 7.4.3, 7.4.4 and 7.4.5). Preference should always be given to those controls higher in the hierarchy.

7.4 Methods of controlling risks for work at height of 2 metres or more

This section provides detailed guidance on reasonably practicable physical fall prevention measures for use in general construction. The guidance is set out in the order of the hierarchy of control described in section 5. Wherever it is reasonably practicable to do so, controls at the top of the hierarchy must be implemented before consideration is given to implementing lower order controls.

However, the methods selected should be appropriate to the particular task, the severity of risk, and the workers involved, having regard to what is reasonably practicable.

Level 1 Controls

7.4.1 Work on the ground (Level 1 control)

Eliminating the need to work at height is the most effective way of protecting the safety of workers.

Designers and persons with control of construction work should consider how work can be done at ground level and eliminate the need to work at height.

Examples of elimination include:

- > prefabrication of roofs at ground level
- > prefabrication of wall frames horizontally, then standing them up
- > using precast or tilt-up concrete construction instead of concrete walls constructed in situ
- > using paint rollers with extendable handles, and
- > using remote release clutches for crane lifted loads positioned at height

7.4.2 Work from a solid construction (Level 1 Control)

Many areas of a construction site can be turned into solid construction. Careful and ongoing assessment of the physical location is needed to eliminate areas in which workers could fall.

‘Solid construction’ means an area that has:

- > a surface capable of supporting people and material and any other loads applied to it
- > protection at its perimeter and around all open penetrations from, or through which, workers could fall
- > an even and readily negotiable surface and gradient, and
- > a safe means of access and egress.



Solid construction must satisfy all of the following requirements:

Structural strength

Different types of work involve different loads on the supporting surface. Make sure that the surface and its supports can safely carry the expected loads – including workers, material, tools and equipment. When in doubt, make sure a structural engineer determines the safe load capacity before use.

Surface and gradient

Surfaces should be non-slip and free from trip hazards and penetrations.

Smooth surface working areas should not be steeper than 7 degrees (1 in 8 gradient). Cleated or grated surfaces, which provide greater slip resistance, should not be steeper than 23 degrees (approximately 1 in 2.4 gradient).

Edge protection

Perimeter protection must be provided on the exposed edges of all work areas. These include:

- > the perimeters of buildings or other structures
- > the perimeters of skylights or other fragile roof materials, and
- > openings in floor or roof structures.

Additional void protection

Where there is a risk that workers performing tasks from work platforms or ladders may fall over the guardrailing, precautions should be taken to ensure that stairwells and other openings are covered. Coverings should be secured in place to prevent dislodgment and be designed to withstand any loads that may be imposed during construction works or in the event of a fall.

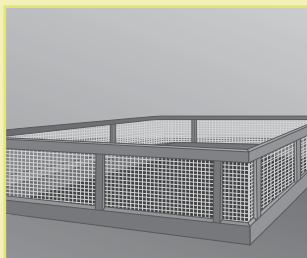

Figure 6: Guardrails protecting an open penetration through the slab.

Courtesy of WorkSafe Victoria, Code of Practice – No. 28 – Prevention of Falls in General Construction, 31 March 2004.³

3 For further information and future updates, please access www.worksafe.vic.gov.au



Access and egress

Every solid construction must have safe and suitable access and egress. Common means of access and egress include:

- > existing floor levels
- > permanently installed platforms, ramps, stairways and fixed ladders complying with AS 1657 or most recent equivalent
- > temporary access ways and temporary stair systems, and
- > secured single portable ladders set up at a slope of between 4:1 and 6:1, and extending at least 900 mm above the stepping-off point.

Ladder and stairway landings require the same level of edge protection adjacent to their open sides and ends as solid construction.

Where possible, stepladders and trestle ladders should not be used for access to or egress from solid construction.

Level 2 Controls

7.4.3 Passive fall prevention devices (Level 2 control)

Passive fall prevention devices include temporary work platforms, such as roof safety mesh, perimeter scaffolding, perimeter guardrailing, barriers and perimeter screens.

Temporary work platforms

A temporary work platform is a platform that provides a working area for the duration of work carried out at height, and which is designed to prevent a person from falling. It encompasses a wide variety of plant and equipment and includes scaffolds, elevating work platforms, mast climbers, work boxes and purlin trolleys.

Scaffolds

Scaffolds are a common means of providing a safe working platform for working at height. There is a wide variety of scaffolding systems available.

Working platforms on scaffolds are generally rated as light, medium or heavy duty.

- > Light duty – up to 225 kg per bay. This is suitable for plastering, painting, electrical work, and other light tasks
- > Medium duty – up to 450 kg per bay. This is suitable for general trades work
- > Heavy duty – up to 675 kg per bay. This is what is needed for bricklaying, concreting, demolition work and most other work tasks involving heavy loads or heavy impact forces
- > Special duty – has a designated allowable load as designed.



These safe load limits include the weight of people (which is taken to be a nominal 80 kg per person) plus the weight of any materials, tools and debris on the working platform. Therefore, a properly constructed mobile scaffold with a light duty platform can safely support one worker and 145 kg of tools and material, or two workers and 65 kg of tools and materials.

All scaffolding must be erected, altered and dismantled by competent persons. Any scaffold from which a person or object could fall more than 4 metres must be erected, altered and dismantled by or under the direct supervision of a licensed scaffolder.

Scaffolds should comply with AS/NZS 4576 and AS/NZS 1576 Scaffolding series or their most recent equivalents:

- > AS/NZS 1576.1
- > AS 1576.2
- > AS/NZS 1576.3
- > AS 1576.4
- > AS/NZS 1576.5, and
- > AS/NZS 1576.6.

AS/NZS 4576 provides practical guidance on training, safe work practices, inspection and use of scaffolding and scaffolding equipment.



Figure 7: Perimeter scaffold with a fully decked working platform, guardrails and toeboards.

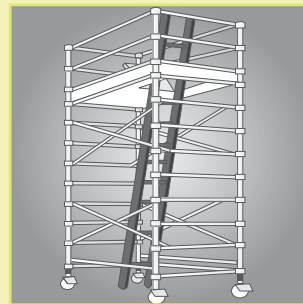

Figure 8: Mobile scaffold with an access ladder and a trapdoor to provide the largest possible hazard-free working platform

Courtesy of the Commission for Occupational Safety and Health, Western Australia, Code of Practice: Prevention of Falls at Workplaces, 2004⁴

Information, instruction and training for workers using scaffolds

Where work is performed from a scaffold, employers must ensure that the relevant workers understand:

- > what loads the scaffold can safely take (such as how many bricks per bay)

⁴ For further information and future updates, please access www.worksafe.wa.gov.au



- > not to make any unauthorised alterations to the scaffold (such as removing guardrails, planks, ties, toeboards and braces)
- > that working platforms need to be kept clear of debris and access obstructions along their length, and
- > that incomplete or defective scaffolds must never be accessed.

Where work is performed using mobile scaffolds, workers should understand that the scaffold:

- > should remain level and plumb at all times
- > be kept well clear of powerlines, open floor edges and penetrations
- > never be accessed until the castors are locked to prevent movement
- > never be moved while anyone is on it, and
- > never be accessed up the outside - use internal ladders only.

Trestle scaffolds

Trestle scaffolds may be used at heights greater than 2 metres only when guardrailing and toeboards are incorporated to prevent people and material falling off the open side or end of the working platform. The system (including planks) should be assembled according to the manufacturer's specifications. Trestle scaffolds without guardrailing are only suitable for tasks requiring a work platform of less than 2 metres. Some trestle ladder scaffolds include outriggers to increase stability. Trestle ladder scaffolds are only suited to light duty tasks such as painting and rendering.

When adjusting the height of a trestle scaffold, make sure that only the purpose-designed pins are used. Do not use nails or pieces of reinforcing bar.

Work should only be performed between the trestles. The working platform of a trestle scaffold should be a minimum of two planks or 450 mm wide. The maximum spacing of trestles should not exceed the maximum recommended span of the scaffold planks. Since 1993 random length scaffold planks manufactured in accordance with AS 1577 or most recent equivalent have this information marked on them. Where this information is not known, reference should be made to Table 1.

Table 1: Maximum span of solid timber scaffold planks complying with AS 1577

Nominal thickness of plank (mm)	Maximum span (m)
38	1.5
50	2.0
63	2.5

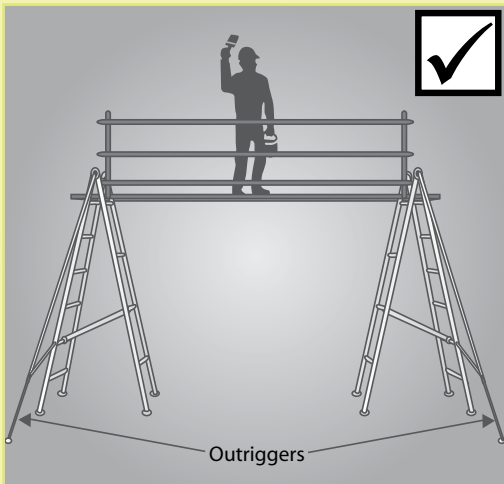

Figure 9: A correctly set-up trestle scaffold showing guardrailing and outriggers (toeboards not shown).

Courtesy of WorkSafe Victoria, Code of Practice – No. 28 – Prevention of Falls in General Construction, 31 March 2004.⁵

Further guidance on the use of scaffolds is provided in AS/NZS 4576 or most recent equivalent. Specific regulations concerning the use of scaffolds exist in some jurisdictions. The relevant state or territory OHS Authority should be consulted for local requirements.

Elevating work platforms

EWPs are available in a wide variety of types and sizes. They include scissor lifts, cherry pickers, boom lifts and travel towers. There are battery powered and internal combustion engine types. Some are designed for hard flat surfaces only, while others are designed for operation on rough terrain.

EWPs:

- > should only be used on a solid, level surface; the surface area should be checked to make sure that there are no penetrations or obstructions that could cause uncontrolled movement or overturning of the platform
- > when designed as ‘rough terrain’ units, may be used on other surfaces in accordance with manufacturers directions; the surface area should be checked for unacceptable penetrations or obstructions, and
- > should be clearly marked with the safe working load limit.

Operators working in travel towers or boom type elevating work platforms must wear an anchored safety harness in accordance with AS 2550.10 or most recent equivalent. The harness system used must be able to arrest a fall before the user strikes the ground.

⁵ For further information and future updates, please access www.worksafe.vic.gov.au

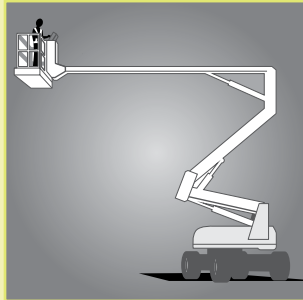
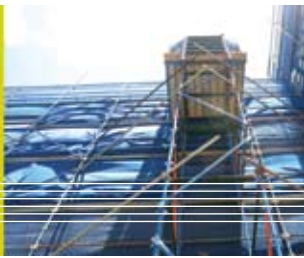

Figure 10: An example of a boom-type EWP. The safety harness and lanyard assembly are not shown for purposes of clarity. The lanyard should be as short as possible and should be attached directly to the designated anchor point, not to the handrail.



Figure 11: An example of a scissor-lift EWP. As with boom-type platforms, people should not climb onto or off the platform when it is in an elevated position.

A fall injury minimisation system is not required on this item of plant, unless advised by the manufacturer, or indicated in the risk assessment, and a suitable anchor point is provided.

Courtesy of the Commission for Occupational Safety and Health, Western Australia, Code of Practice: Prevention of Falls at Workplaces, 2004⁶

People operating EWPs with boom lengths exceeding 11 metres should have an appropriate certificate of competency.

It is a requirement of most jurisdictions that the design of an EWP be registered with a state or territory OHS Authority.

Further information on the safe use of EWPs is provided in AS 2550.10 or most recent equivalent.

Mast climbing work platforms

Mast climbing work platforms are hoists with a working platform that is used to raise personnel and material to a temporary working position. They use a drive system mounted on an extendable mast, which may be tied to a building.

⁶ For further information and future updates, please access www.worksafe.wa.gov.au



Mast climbing work platforms can be set up in either single-mast or multi-mast configurations. They are generally not suitable for use if the profile of a structure changes at different elevations (for example, if the upper floors of a building 'step' back or balconies protrude from the building).

The erection and dismantling of mast climbing work platforms must be carried out, or directly supervised, by a person holding an appropriate rigging or scaffolding license.

It is a requirement of most jurisdictions that the design of a mast climbing work platform and a crane work box be registered with a state or territory OHS Authority.

Further information on mast climbing work platforms is provided in AS 2550.16 or most recent equivalent.

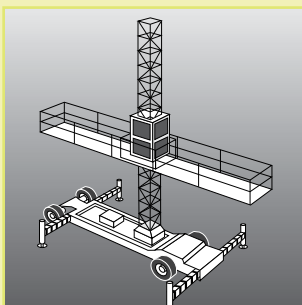

Figure 12: An example of a typical mast climbing work platform.

Courtesy of WorkSafe Victoria, Code of Practice – No. 28 – Prevention of Falls in General Construction, 31 March 2004.⁷

Work boxes

A work box is a personnel carrying device designed to be suspended from a crane for the purpose of providing a working area for persons elevated by and working from the box. They consist of a platform surrounded by an edge protection system, and should be designed in accordance with AS 1418.17 or most recent equivalent.

Other work platforms should be used instead of workboxes if at all practicable.

For specifications for the use of crane work boxes refer to AS 2550.1 or most recent equivalent.

Purlin trolleys

Purlin trolleys travel on top of purlins (horizontal beams running along the length of a roof) and can be used to support material and roof workers. They may be used during installation or removal of roof coverings.

Before a purlin trolley is placed on a roof structure, advice should be obtained from an engineer on whether the roof structure is suitable for the particular purlin trolley and its operational loads.



The purlin trolley should have a holding brake and a device to prevent its inadvertent dislodgment from the supporting purlins.

Fall prevention should be provided at all times for people working from the purlin trolley, preferably through the use of guardrails. If this is not reasonably practicable, a safety harness anchored to the trolley should be provided and used. The trolley should be provided with suitable safety harness anchorage points complying with AS/NZS 1891.4 or most recent equivalent. Persons using individual fall-arrest systems should be adequately trained and supervised.

Perimeter protection

Perimeter screens

Perimeter screens that are purpose-designed for a building provide a high level of protection in preventing construction workers and any debris, tools or building material from falling from the building.

Some screens incorporate prefabricated formwork to enable the casting of perimeter edge beams or stop ends for the edge of the floor. They may also be designed to cover two or more floors, with trailing screens to protect construction workers on lower levels while they are stripping the formwork and installing back propping.

Perimeter screens normally extend one floor above the floor they are supported from. The top of the screen should be high enough to provide perimeter protection for the floor that is to be built before anyone has to access this floor or its formwork deck. The framework supporting the screen should be able to bear the load of the screen. The mesh should be of minimum gauge 2.5 mm, and have a maximum mesh opening size of:

- a. 25mm nominal where no lining is used, or
- b. 50mm nominal where lining is used.

Perimeter screens should be designed by an engineer and fitted by licensed riggers in accordance with the design engineer's requirements. Gaps between screens and between the screens and the structure should not exceed 25mm.

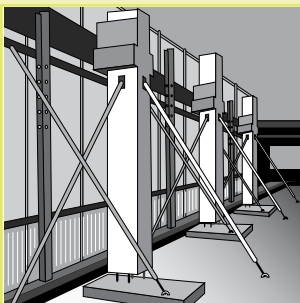

Figure 13: An example of a perimeter screen secured by props

Courtesy of WorkSafe Victoria, Code of Practice – No. 28 – Prevention of Falls in General Construction, 31 March 2004.⁸



Some jurisdictions regulate the types of material used to construct perimeter screens. There are also specific requirements for mesh screens, including the maximum allowed size of mesh openings, the gauge of the mesh, and the use of linings with mesh.

The relevant state or territory OHS Authority should be consulted for local requirements.

Perimeter guardrails

Guardrails may be used to provide effective fall prevention at:

- > the edges of roofs and roof framing
- > the edges of scaffolds
- > the edges of work platforms, suspended slabs, formwork and falsework, walkways, stairways, ramps and landings
- > the perimeters of buildings and other structures
- > the perimeters of skylights and other fragile roof material
- > openings in floor and roof structures, and
- > the edges of shafts, pits and other excavations.

Before a guardrail system is adopted, the person with control should ensure it will be adequate for the potential loads. The required load resistance will depend on the momentum of a falling person. For example, the momentum of a person falling from a pitched roof will increase as the pitch (or angle) of the roof increases.

Proprietary systems should be configured, installed, used and dismantled by a competent person in accordance with the manufacturer's instructions.



Figure 14: This temporary guardrail is being used instead of mesh to permit work on curtain wall securing bolts.

Courtesy of WorkSafe Victoria, Code of Practice – No. 28 – Prevention of Falls in General Construction, 31 March 2004.⁹



Figure 15: Common examples of acceptable guardrail arrangements for roof work (for clarity, toeboards are not shown).

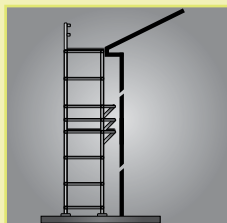

Fig. 15(a) Scaffold platform at edge of roof with hop-up bracket for other trades

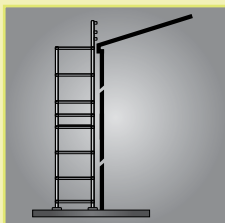

Fig. 15(b) Inside standards supporting guardrails

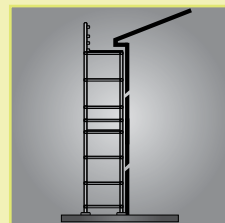

Fig. 15(c) Scaffold platform at edge of roof with hop-up bracket for other trades

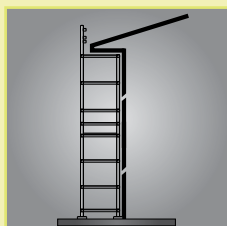

Fig. 15(d) Outside standards supporting guardrailing.

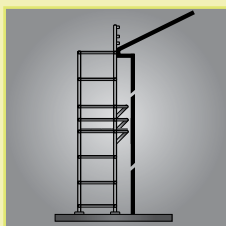

Fig. 15(e) Inside standards supporting guardrailing with hop-up bracket for other trades.

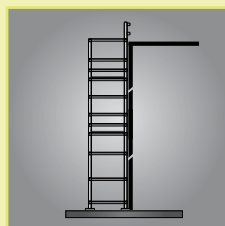

Fig. 15(f) Inside standards supporting guardrailing adjacent to a flat roof structure.

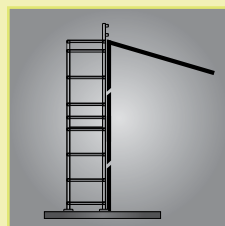

Fig. 15(g) Inside standards supporting guardrailing adjacent to a roof structure that slopes away from the top edge.

Courtesy of the Commission for Occupational Safety and Health, Western Australia, Code of Practice: Prevention of Falls at Workplaces, 2004¹⁰

Guardrailing the edges of roofs

Guardrailing may be used as fall prevention around the edge of a roof as a proprietary designed system or through incorporation into scaffolding. The following diagrams show common examples of acceptable roof guardrailing arrangements on scaffolding. The toeboards are not shown for clarity.

Guardrails should comply with AS 1657 and/or AS/NZS 4576 or their most recent equivalent.

Further information on guardrails for roofs can also be found in the series AS/NZS 4994 or most recent equivalent.

State and territory legal requirements should be checked with the relevant OHS Authority before guardrails are installed.

Where the slope of the roof exceeds 35 degrees, the roof is an inappropriate surface to stand on. Perimeter guardrails and catch platforms are inappropriate measures to protect workers on a steeply sloping roof.

¹⁰ For further information and future updates, please access www.worksafe.wa.gov.au



In these circumstances, roof workers need a system to prevent sliding and to prevent falls from the perimeter, comprising one or more of the following:

- > aerial access equipment, such as an EWP
- > a work positioning system, such as travel restraint or industrial rope access system
- > a scaffold platform, located at the roof edge, and
- > a roof ladder.

Proprietary systems should be configured, installed, used and dismantled in accordance with the manufacturer's instructions.

Barriers to restrict access

Barriers should be used to cordon-off elevated areas including roofs and balconies where edge protection is not provided and people are not permitted to access. The barriers should be secure and restrict access to authorised people only. Signage should be erected which warns against entry to those areas.

Where possible, barriers should be placed at least 2 metres in from any unprotected edge or opening. They can include steel mesh panels, metal post and rails and metal posts with timber rail assemblies. They should be highly visible and securely fixed to prevent displacement.

Safety mesh

Safety mesh is designed to prevent internal falls through a roof, which is one of the most common fall problems in the Construction industry. If securely fixed, safety mesh provides fall protection for roof installers and offers long-term protection against falling for maintenance and repair workers. Safety mesh should be formally inspected and certified as being installed in accordance with the manufacturer's instructions. The inspection and certification of the safety mesh must be performed by a competent person. Where existing safety mesh is to be used to control the risk of workers falling, the integrity of the mesh and its fixings should also be verified by a competent person prior to use.

Safety mesh **does not** control the risk of perimeter falls or through penetration hazards. Therefore, safety mesh should always be used in conjunction with appropriate edge protection, guardrails or fall-arrest systems and devices. Used in conjunction with these control measures, safety mesh is the preferred system for protection against falling for workers laying roof sheets.

Appendix 3 provides further guidance on the installation of safety mesh.

Level 3 Controls

7.4.4 Work positioning systems (Level 3 control)

A work positioning system is equipment that enables a person to be positioned and safely supported at a work location for the duration of the task being undertaken at height. Work positioning systems require a higher level of operator competency and supervision than control measures which are higher on the hierarchy of control (see section 5). Accordingly, they should only be used where it is not reasonably practicable to use higher order controls.



Industrial rope access systems

Industrial rope access systems are used for gaining access to, and working at, a workplace, usually by means of vertically suspended ropes. Although fall-arrest components are used in the industrial rope access system, the main purpose of the system is to gain access to a work area rather than to provide backup fall protection. Other methods of accessing a work face should be considered (for example, EWPs or building maintenance units) before rope access systems, as a high level of skill is essential for their safe use.

Industrial rope access systems require a high level of competency on the part of the user and supervisors to ensure safe use. Users, including supervisors, should undertake a competency based course of training such as those approved by the Australian Rope Access Association (ARAA) or equivalent.

For further guidance on industrial rope access systems, readers should refer to the series AS/NZS 4488 or most recent equivalent and the ARAA Industry Code (September 2005)

Travel restraint systems

A travel restraint system prevents the user from approaching an unprotected edge on a building or structure. Generally, the system consists of a safety belt or harness that is connected by a lanyard to a suitable anchorage point or static line. The system must be set up to prevent the wearer from reaching the edge.

Where a temporary roof anchor is used as an anchorage for a travel restraint system it must be installed in accordance with the manufacturer's or designer's instructions.

The roof or other building component to which an anchor is to be attached must be checked by a competent person to verify that it is suitable for supporting the anchor.

It is preferable that travel restraint systems are used in conjunction with other fall prevention methods, such as guardrails, safety nets and catch platforms.

Travel restraint systems should conform to the AS/NZS 1891 series or their most recent equivalent.

Note: Travel restraint systems are not fall-arrest devices.

Typical anchorage points for travel restraint systems are not designed for the impact loads applied in the event of a fall. Therefore, where there is any possibility that a person using a travel restraint device may approach an edge from where a fall is possible, a travel restraint system should not be used.



Figure 16: Travel restraint system options.

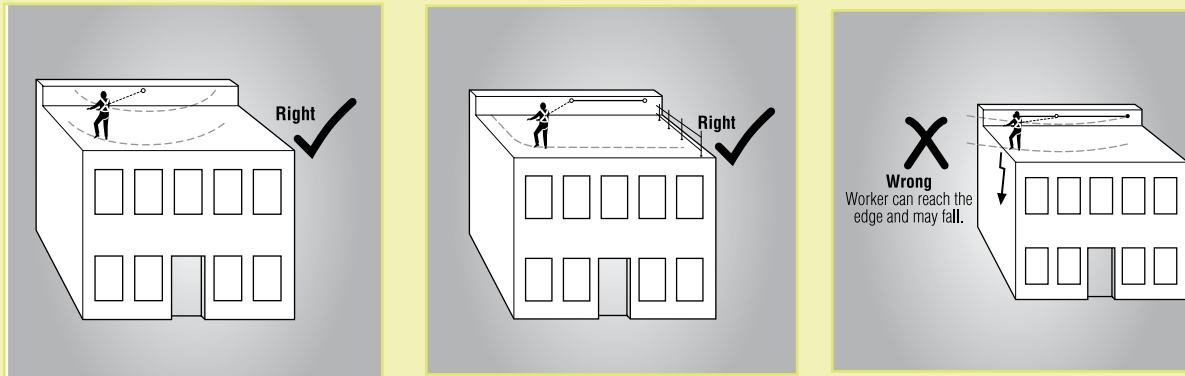

Courtesy of the Commission for Occupational Safety and Health, Western Australia, Code of Practice: Prevention of Falls at Workplaces, 2004¹¹

Use of a fall-arrest system instead of a restraint system

Although fall-arrest systems are not preferred (being low in the hierarchy of control measures), an individual fall-arrest system should be used instead of a travel restraint system if any of the following situations apply:

- > the user can reach a position where a fall is possible
- > the user has a restraint line that can be adjusted in length so that a free fall position can be reached
- > there is a danger the user may fall through the surface (e.g. fragile roofing material), and
- > there is any other reasonably likely use or misuse of the system which could lead to a free fall.

Level 4 Controls

7.4.5 Fall injury minimisation systems (Level 4 control)

A fall injury minimisation system means equipment and/or materials that are intended to prevent or reduce the severity of an injury to a person if a fall does occur. It includes, where appropriate, industrial safety nets, catch platforms and safety harness systems (other than a travel restraint system).

Fall injury minimisation systems should **only** be used if it is not reasonably practicable to use higher level control measures of the types described in sections 7.4.1 through 7.4.3 (Level 1, 2 and 3 controls), or if these higher levels of control might not be fully effective in preventing a fall on their own.



There are two examples listed below:

Catch platforms

A catch platform is a temporary platform located below a work area designed to catch a falling person. The platform should be of robust construction and designed to withstand the maximum potential impact load. Scaffolding components may be used to construct fixed and mobile catch platforms.

Catch platforms should:

- > incorporate a fully planked-out deck
- > be positioned so the deck extends at least 2 metres beyond all unprotected edges of the work area, except where extended guardrailing is fitted to the catch platform
- > be positioned as close as possible to the underside of the work area. It is recommended that the distance a person could fall before landing on the catch platform should be no more than 1 metre, and
- > always be used with an adequate form of edge protection.

Heavy duty trestle scaffolds and split-head trestle scaffolds can provide simple and inexpensive catch platforms. The latter are particularly effective in openings and stairwells.

Fall-arrest systems

The hazards of using a fall-arrest system are considerable. Their use should only be considered where measures higher in the hierarchy of control are not reasonably practicable.

A fall-arrest system should only be used where it is not reasonably practicable to use a fall prevention measure, or where the fall prevention applied is not fully effective on its own. A fall-arrest system requires considerable skill to use safely, and in the event of an arrested fall, it is likely to cause some physical injury to the user. People using a fall-arrest system should wear adequate head protection to protect them in the event of a fall.

A fall-arrest system is intended to safely stop a worker falling an uncontrolled distance and reduce the impact of the fall. It is an assembly of inter-connected components, comprising a harness connected to an anchorage, either directly or by means of a lanyard. Fall-arrest systems can be used where workers are required to carry out their work near an unprotected edge.

Fall-arrest systems should be evaluated to ensure not only that they will be effective, but also that no new hazards will be created by their use. Examples of possible new hazards include trip hazards, and such severe restrictions on a person's movements that they cannot safely perform their tasks.

A person must not use a fall-arrest system unless there is at least one other person on the site who can rescue them if they fall. In some situations, at least two people are required to safely rescue a person who has fallen.

For more guidance see Appendix 6 – Fall-arrest systems.



Level 5 Controls

7.4.6 Use of ladders (Level 5 control)

Ladders are a Level 5 control, and may be used when it is not reasonably practicable to use a higher order control measure.

Ladders should be used primarily as a means of access to or egress from a work area. They should only be used as a work platform if:

- > other methods of working at the required height are not reasonably practicable, and
- > a risk assessment is carried out to minimise the risks associated with the work to be done from the ladder.

Selection of ladders

Ladders must be correctly selected for the task to be undertaken. In doing this, the duration of the task, the physical surroundings of where the task is to be undertaken and the prevailing weather conditions must be taken into consideration. For example, metal ladders or metal reinforced ladders should not be used for live electrical work.

Typically, ladder use for construction work involves repetitive, high volume use and handling, requiring them to be of robust design and construction. Ladders used for construction work should be industrial grade, not domestic grade.

Safe use of ladders

Any ladder used at a workplace must be set up on a surface that is solid and stable, and set up so as to prevent the ladder from slipping.

Slipping of ladders can be prevented by:

- > placing single and extension ladders at a slope of 4 to 1, and setting up stepladders in the fully opened position, and
- > securing single and extension ladders at both the top and bottom.

Figure 17: Some effective ways of securing a ladder.

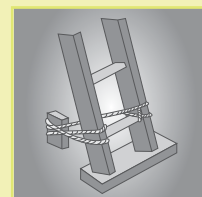
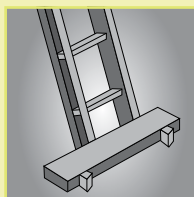
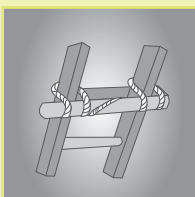

Courtesy of WorkSafe Victoria, Code of Practice – No. 28 – Prevention of Falls in General Construction, 31 March 2004.¹²



People using ladders should not:

- > handle or use ladders where it is possible for the worker or the ladder to make contact with powerlines
- > use metal or metal reinforced ladders when working on live electrical installations
- > set up the ladder in places, such as driveways and doorways, where a person or vehicle could hit it without appropriate safeguards, such as erecting a barrier or locking the door shut
- > use a ladder near the edge of an open floor, penetration, or on scaffolding to gain extra height
- > over-reach (the worker's belt buckle should be within the ladder stiles throughout the work)
- > use any power (air, hydraulic, electric or battery) equipment or tool, specifically designed to be operated with two hands, such as concrete cutting saws and circular saws
- > use tools which require a high degree of leverage type force which, if released, may cause the user to over balance or fall from the ladder, such as stillsons or pinch bars
- > carry out work such as arc welding or oxy cutting
- > work over other people, and
- > allow anyone else to be on the ladder at the same time.

Except where a pole strap (or similar device providing the user with full body support) is used, any person using a ladder should not:

- > face away from the ladder when going up or down, or when working from it
- > stand on a rung closer than 900mm to the top of a single or extension ladder, and
- > stand higher than the second tread below the top plate of any stepladder.

Where possible, ladders being used as access should be set up at right angles to the working surface to allow workers to step off the ladder rather than having to step around or over the ladder.

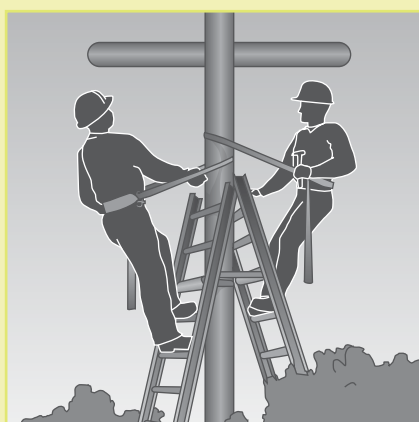

Figure 18: Pole straps used with portable ladders

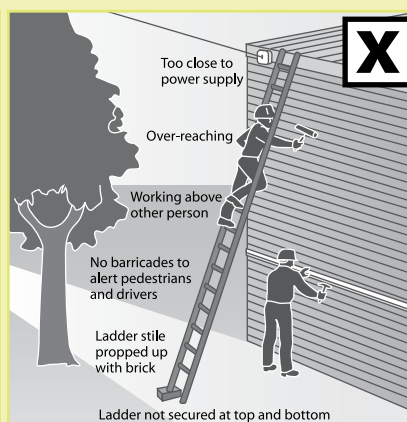

Figure 19: Unsafe ladder use.

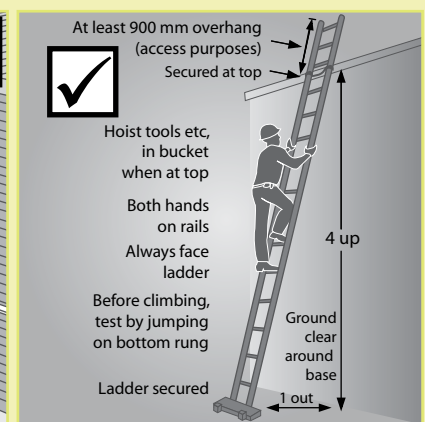

Figure 20: Acceptable ladder use.

Courtesy of WorkSafe Victoria, Code of Practice – No. 28 – Prevention of Falls in General Construction, 31 March 2004.¹³

13 For further information and future updates, please access www.worksafe.vic.gov.au



Ladder maintenance

Ladders should be regularly inspected by a competent person. Ladders with any of the following faults should be replaced or repaired:

- > timber stiles warped, splintered, cracked or bruised
- > metal stiles twisted, bent, kinked, crushed or with cracked welds or damaged feet
- > rungs, steps, treads or top plates which are missing, worn, damaged or loose
- > tie rods missing, broken or loose
- > ropes, braces, or brackets which are missing, broken or worn, and
- > timber members that, apart from narrow identification bands, are covered with opaque paint or other treatment which could disguise faults in the timber.

Further guidance can be obtained from the series AS/NZS 1892 and AS/NZS 1657 or their most recent equivalent.

7.4.7 Administrative controls (Level 5 control)

Administrative controls are systems of work or work procedures that help to reduce the exposure of employees to fall hazards where it is not reasonably practicable to use higher level controls.

They may be used to support other control measures that are put in place. For example, work procedures may be needed to ensure the safe use of temporary work platforms, fall injury minimisation systems and ladders. Administrative controls may also be needed to limit the time workers are exposed to a fall hazard and/or the number of workers involved in the task.

It is essential to involve contractors and other workers in the development of administrative controls. People who perform a task regularly often have a good understanding of the risks involved.

Administrative controls may include 'no go' areas, permit systems, the sequencing of work and safe work procedures.



Figure 21: Example of signage for a 'no go' area.

Courtesy of WorkSafe Victoria, Code of Practice – No. 28 – Prevention of Falls in General Construction, 31 March 2004.¹⁴

'No go' areas

'No go' areas can be an effective method of making sure people are not exposed to fall hazards. They require adequate signage to warn against access to the hazardous area. They can be used to highlight



the risks of entry to an area where there is an unguarded fall hazard, or to areas where work is being undertaken overhead and there is a risk of falling material.

Persons with control of the construction project or construction work should ensure that relevant information and instruction is provided to construction workers on the site about 'no go' areas, and that there is adequate supervision to ensure that no unauthorised worker enters the 'no go' area.

Further guidance on safety signs can be obtained from AS 1319 or most recent equivalent.

Permit systems

Permit systems ensure that only competent persons trained in the use of appropriate control measures work in an area where there is a fall hazard.

Examples include:

- > tagging all access points to a scaffold to prevent unauthorised access during erection and dismantling, with 'only licensed scaffolders permitted on an incomplete scaffold', and
- > requiring permits for access to areas where travel restraint systems or fall-arrest systems are to be used.

Organising and sequencing of work

Make sure that the work is organised so that people do not interfere with or increase the risk of a fall for themselves or others. For example, sequence jobs so that different trades are not working above or below each other at the same time. Plan the work so tasks are not performed for extended periods from a ladder, or so that work at height is minimised in extremely hot or cold weather.

Safe work procedures

An administrative control may be as simple as a safe work procedure that describes the steps involved in safely undertaking a task. It may also include any particular training, instruction and the level of supervision required.

A safe work procedure can be generic and applicable to a task that is routinely or repeatedly carried out.

Recording administrative controls

If administrative controls are used as a means of reducing the risk associated with a particular task, the person with control of the construction work should make sure details of the task and the controls are recorded.

These records should be kept until the work covered by the administrative controls has been completed.

A single administrative control, such as a safe work procedure, may apply to a task that is repeatedly carried out at single or multiple workplaces.

However, the record should make it clear which particular task the administrative control applies to and the location(s) where the task is being undertaken. If relying on administrative controls, it will be necessary to provide a high level of supervision to ensure that the safe work procedure is being adhered to. The procedures should be regularly reviewed to gauge the effectiveness of the procedures.



8. TRENCHING AND EXCAVATION WORK

Excavation work can expose persons to the risk of injury from a wide range of hazards. However, consistent with the purpose and scope of this Code, this chapter focuses on trenching and excavation work that presents the risk of a fall from height and provides general guidance only. For specific guidance on work systems and factors such as benching, battering and shoring, reference should be made to the respective information bulletins and codes of practice produced by the state and territory OHS Authorities.

Trenching and excavation work have the potential to expose persons to the risk of injury from falls from height. Many incidents on construction sites have involved people, including young children, sustaining serious injury from falls into open trenches and excavations. Even shallow excavations can be trip and fall hazards, although the likelihood of injury when a person falls increases with the depth of the trenching or excavation work.

For more information on risk assessment processes, control measures and instruction and training, see section 4 of this Code.

8.1 Duties

The National Standard for Construction Work requires persons in control of construction projects or work to maintain, so far as is reasonably practicable, a working environment that is safe and without risk to health. The National Standard also requires SWMSs to be developed for all high-risk construction work. High-risk construction work includes work involving excavation to a depth greater than 1.5 metres.

Persons in control of a construction project or construction work where there is a risk that someone undertaking construction work could fall 2 metres or more must ensure that physical fall prevention measures are provided, so far as is reasonably practicable.

8.2 Risk assessment

For any trenching or excavation work a risk assessment should be conducted in order to identify the fall hazards and determine which control measures will be implemented to eliminate or minimise the risks arising from those hazards.

If the risk assessment is for construction work where there is a risk that someone could fall 2 metres or more, physical fall prevention measures must be provided so far as is reasonably practicable.

The risk assessment should also take into consideration the security of the excavation, both during work and when left unattended. Consideration should be given to factors such as:

- > how long the excavation will be left open, and
- > who may gain access to the excavation (including pedestrians and children).

Aside from 'high risk' construction work, SWMS and physical fall prevention measures are not mandatory when there is **not** a risk that a person could fall 2 or more metres, although persons have the option of using a SWMS and physical fall prevention measures for the work if the risk assessment identifies a need for such measures to be used.



8.3 Control measures

Control measures to prevent persons being injured from a fall from height during the excavation work must be provided and should be properly installed and maintained until the work is completed, or until a further risk assessment identifies that there is no longer any risk of persons falling into the excavation.

Some control measures that should be considered are:

- > the application of physical fall prevention measures
- > isolating the trench or excavation by the use of perimeter fencing, barricades, barriers, screens, handrails and trench covers, which are capable of preventing access or preventing a person from falling
- > pedestrian detours which should be clearly defined and protected
- > the provision of a safe means of movement between different levels of the excavation
- > the use of intermediate platforms for deep excavation, and
- > backfilling the excavation as work progresses.

When barriers are used they should be placed at least 2 metres from the edge of the trench where possible. They should be highly visible and capable of remaining in place during adverse weather conditions. Safety type tape is not an adequate physical barrier as it is hard to see in low light conditions and can be easily broken. Unless they are specifically designed for the purpose, barriers should not be used as guardrails.

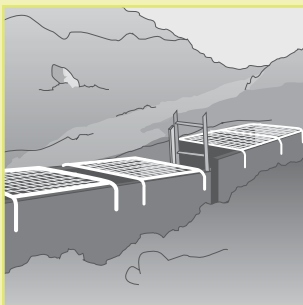

Figure 22: Fall prevention for trenching works - steel mesh covers over trench shields.

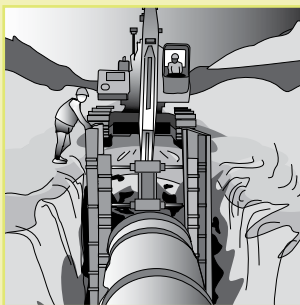

Figure 23: Example of a section of trench shoring extending above the excavation for fall protection.



Figure 24: Example of an unguarded trench.



9. APPENDICES

APPENDIX 1 – DESIGN CONSIDERATIONS

The preferred approach is always the elimination of fall hazards. Consideration of the potential risks of falls from height early in the design stage can result in the elimination or better control of such risks for construction workers. Where this is not possible, one way to minimise fall risks at the design stage is to integrate fall prevention systems into the design. This can improve safety in both the construction phase and in subsequent maintenance tasks.

Safety considerations at the design stage could include:

- > safe access to and egress from any work area, including the roof
- > designing permanent guardrails or other forms of edge protection (e.g. parapet walls) for permanent fall prevention on roofs
- > future maintenance requirements, especially in relation to sloping building exteriors and windows, to ensure maintenance can be carried out safely
- > specifying the strength of roof members and other points to which guardrail, or anchor points for work positioning systems will be fixed
- > safer building design generally, with, for example:
 - 900 – 1100mm parapet walls
 - low-level mounting of roof vents
 - the location of air conditioning units and other roof-mounted plant, such as satellite dishes, away from edges
 - the location of air conditioning and similar plant at ground level
 - the specification of non-fragile, trafficable material for the roof
 - the use of permanent safety mesh
 - safer gutters, for example, installing large volume gutters and down pipes to minimise the need to access the roof for cleaning, locating the gutters at ground level or away from edges, or the removal of gutters altogether, with a smooth transition from the roof to the walls with the gutters at ground level
- > specific safety requirements for particular workers doing subsequent installation, maintenance or repair work. These groups include:
 - people installing and maintaining antennae and satellite dishes
 - contractors servicing air conditioning and other equipment located on the roof or otherwise at height
 - window and gutter cleaners and repairers, and
- > designing the pre-fabrication of structures on the ground before they are lifted into position.



APPENDIX 2 SAFE WORK METHOD STATEMENT (SWMS)

WORKING WITH A SWMS

Safety management is about reducing the risk of injury or harm for any person who may be affected by the work. This includes employers, contractors, all workers, visitors and members of the public who may be at or near a work site.

The work should be organised so that all of these people can carry out their usual activities safely.

COORDINATION

A SWMS is one way of providing information to everyone involved in a particular task. It sets out the method that will be used and the way that risks associated with the task will be managed on that site.

SWMSs also provide the information that is needed for persons with control of the project and site supervisors to coordinate the work. They can refer to the SWMSs to ensure that everyone is following the steps that are to be taken to complete the job safely.

PREPARING FOR WORK

SWMSs are an important part of preparing for each job.

SWMSs should be completed before work begins and each worker involved with the job should know what is in the SWMS for the work they are doing.

TAKING IT STEP-BY-STEP

Completing a SWMS does not have to be a complicated process. It can be as simple as a few dot points under each of the headings in the blank SWMS form on the next page.

Taking it one step at a time will make the whole process easier. It is best done with the people who usually carry out the tasks because they know the job well and they have to follow the SWMS when it is completed.

1. Break the job down into steps and record the steps in the Work Activity column in the order that they would usually occur on site.
2. In the Hazard column, list the ways that anyone could be injured or harmed during each step. Think about all workers and any visitors or members of the public that may be affected.
3. Work out what could be done to make the job safer and prevent the injuries or harm that may occur. Write this in the Risk Control column.
4. In the Person Responsible column, write down the name of the person who has to make sure the controls are actually carried out on the site.
5. Make sure everyone understands that the SWMS should be changed if there is a change to the site and different controls are required. The document should be reviewed and updated regularly.

TRAINING AND SUPERVISION

A SWMS provides a written record of the way a particular task should be done.

The SWMS does not replace the information, instruction, training and supervision that are required to ensure the task is done that way.

It is up to the person with control of the construction project to ensure that each person has the skills to work safely and there is adequate supervision of the work underway at each site.

INTRODUCING SWMSs

It is a requirement that SWMSs are developed for all high-risk construction work activities. Gradually the number of situations where SWMSs are used will grow and they will become a regular part of managing safety on the site.

SAFE WORK METHOD STATEMENT (SWMS) - Blank form - Copy for use at the workplace

Safe Work Method Statement – No. _____					
Work Activity/Task:	Project Name/No: _____				
Legislation/Codes of Practice relevant to this task:	Principal Contractor: _____ Representative: _____	ABN: _____			
_____	Sub-Contractor: _____ Representative: _____	ABN: _____			
_____	This SWMS has been reviewed by:				
Name:	Name: _____				
Signature:	Signature: _____				
Date:	Date: _____				
Responsibility:	The contractor/sub-contractor must issue a Safe Work Method Statement (SWMS) for review. Contractors and sub-contractors must ensure that all their employees have been briefed on their SWMS, trained in the control measures identified and listed in the SWMS, and agree to perform the work according to the SWMS. They must also ensure that immediate corrective action is taken if the SWMS is not being followed.				
Item Note:	Work Activity Break the job down into sequential steps	Identified Hazard What could harm someone? Discuss possible hazards with people working on the site	Risk Control Measures What can be done to make the job as safe as possible?	How will safety measures be implemented? Describe how the identified control measures will be implemented and who will undertake the task(s)	Equipment, qualifications and training What is required to do the job properly?

Example Roof sheeting

Note: this is only a partially completed example and may not address all the hazards for this particular work activity at a specific site. A SWMS that is relevant to an individual site should be prepared.

Safe Work Method Statement – No. _____					
Work Activity/Task:		Project Name/No:			
Legislation/Codes of Practice relevant to this task:		Principal Contractor:	ABN:		
		Representative:			
		Sub-Contractor:	ABN:		
		Representative:			
This SWMS has been prepared by:					
Name:		Name:			
Signature:		Signature:			
Date:		Date:			
Responsibility:					
The contractor/sub-contractor must issue a Safe Work Method Statement (SWMS) for review. Contractors and sub-contractors must ensure that all their employees have been briefed on their SWMS, trained in the control measures identified and listed in the SWMS, and agree to perform the work according to the SWMS. They must also ensure that immediate corrective action is taken if the SWMS is not being followed.					
Item:	Work Activity	Identified Hazard	Risk Control Measures	How will safety measures be implemented?	Equipment, qualifications and training
Note:	Break the job down into sequential steps	What could harm someone? Discuss possible hazards with people working on the site	What can be done to make the job as safe as possible?	Describe how the identified control measures will be implemented and who will undertake the task(s)	What is required to do the job properly?
1	Identify area for placement of work materials				

	FOR EXAMPLE:	FOR EXAMPLE:	FOR EXAMPLE:	FOR EXAMPLE:	FOR EXAMPLE:
2	Identify and establish access/egress to working platforms and work areas	Fall from heights when accessing and exiting the work areas on the roof	Provide appropriate fall protection measures Provide and maintain safe access/egress to and from the roof Maintain good housekeeping throughout the job	Foreman to arrange for scaffolding to be installed Ensure access is built into scaffolding Foreman to ensure that worksite is kept tidy (eg. rubbish removed, tools stowed away...)	Scaffolding needs to comply with appropriate standard Scaffolding needs to be erected by suitably qualified scaffolder Employees aware of site procedures
3	Lifting roof materials to work areas with crane				
4	Install safety mesh to purlins				
5	Install roof insulation				
6	Clean up residual insulation materials from roof area				
7	Lift roof sheets to roof areas				
8	Install roof sheeting				
9	Install down pipes and gutters				



APPENDIX 3 - INSTALLING SAFETY MESH

Safety mesh

Safety mesh is designed to prevent falls through the interiors of roofs. If securely fixed, it provides fall prevention not only for roof installers but for maintenance and repair workers as well.

Safety mesh does not prevent falls from the edge of a roof or through holes in a roof, so it should always be used in conjunction with appropriate edge protection, guardrails or individual fall-arrest systems.

A risk assessment as described in sections 5 and 6 of this Code should be used to identify the most appropriate risk control measures to be used. When used in conjunction with these identified control measures, safety mesh is the preferred system for protecting construction workers against falling through the roof while they are laying roof sheets.

Safety mesh should comply with AS/NZS 4389 or most recent equivalent, which specifies the minimum requirements for the design, construction, testing and installation of safety mesh for use in domestic, commercial and industrial building applications.

The mesh should be formed from 2mm diameter wire of not less than 450 MPa tensile strength, welded into a mesh with the longitudinal wires not more than 150mm apart and the cross wires not more than 300mm apart.

Installing safety mesh

Safety mesh should be installed by competent persons, who should be protected against the risk of falling by the use of appropriate control measures as identified by a risk assessment.

Persons installing safety mesh should only use mesh where the necessary information has been made available by the manufacturer/supplier, including evidence of compliance with AS/NZS 4389 or most recent equivalent. Particular care is required to ensure that the mesh is securely connected to the structure and the overlap between adjacent sections of mesh is sufficient to generate the necessary strength to resist the force of a person falling onto it. The method of installation must be safe; use scaffolding, EWPs, or individual fall-arrest systems to protect workers installing the mesh. The safety mesh should be covered by the roof cladding as soon as reasonably practicable after it has been installed. However, the persons installing the mesh must ensure that this does not happen until such time as the mesh has been formally inspected and certified as being installed in accordance with the manufacturer's instructions.



Figure 25 shows one satisfactory method for installing safety mesh. The mesh is first cut to the right length from the roll and is then run out over the roof using a continuous rope system. Installers should not walk across the open purlins to draw the mesh.

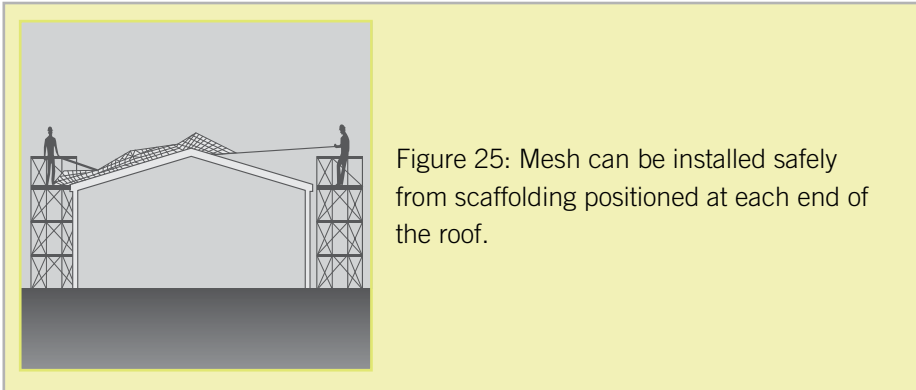

The mesh should be fixed to the purlins by passing each longitudinal wire through a hole drilled in the top of the purlin and tied off with at least four full turns around the wire. If the mesh is being fixed to timber purlins, 40mm x 3.5mm staples should be used (see Figure 26).

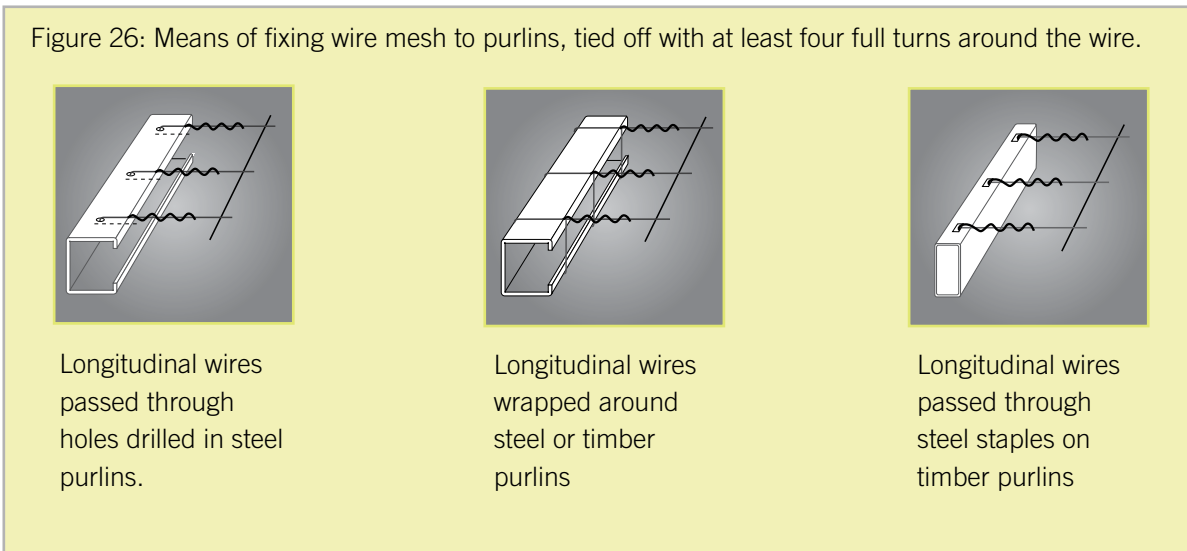

Figures 25 and 26 are courtesy of WorkSafe Victoria, Code of Practice – No. 28 – Prevention of Falls in General Construction, 31 March 2004.¹⁵

Joining of wires in the safety mesh

Adjacent runs of mesh should be side lapped by 150mm (one opening width). If the purlin spacing exceeds 1.7 metres, intermediate fixing with 2mm staples should be provided every second square, as shown below. This intermediate stapling of the mesh should be carried out from underneath the mesh, by persons using suitable physical fall prevention measures.

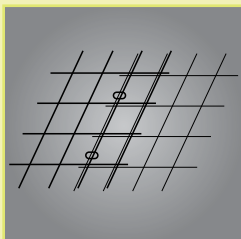
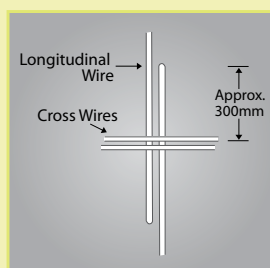

Figure 27: Overlapping of adjacent runs of mesh by one opening width. Steel staples are required to fix runs of mesh where purlin spacing exceeds 1.7 metres.

Courtesy of the Commission for Occupational Safety and Health, Western Australia, Code of Practice: Prevention of Falls at Workplaces, 2004¹⁶

If it is necessary to join two lengths of mesh at their ends, the join should be across the full width of the mesh, with every longitudinal wire being joined. The knot and tie should be the full length of the tail wire, which should be 300 mm long. This tail wire should be tied at least three times around the knot, and the other tail wire should be placed under the longitudinal wire and tied around the transverse wire.

Figure 28: Method for joining longitudinal wires and cross wires (Steps 1 to 4).



Step 1

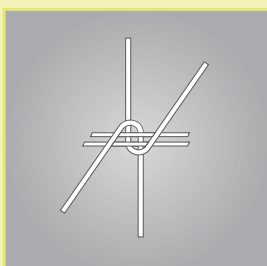

Step 2



Step 3

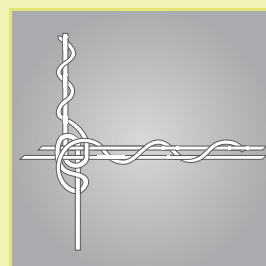

Step 4

Courtesy of WorkSafe Victoria, Code of Practice – No. 28 – Prevention of Falls in General Construction, 31 March 2004.¹⁷

The entire area of the roof frame should be meshed and the mesh then formally inspected and certified as being installed in accordance with the manufacturer's instructions, before the roof is loaded with any bundles of sheeting.

Safety mesh is not a work platform in its own right, and persons should not walk on it. Safety mesh should never be used for access to or egress from a work area.

16 For further information and future updates, please access www.worksafe.wa.gov.au

17 For further information and future updates, please access www.worksafe.vic.gov.au



APPENDIX 4 - ROOF WORK

Roof laying

This appendix provides guidance on the laying of metal deck and similar roofing. Subject to a site-specific risk assessment, roof sheets may be installed on a portal frame structure as follows:

1. Install the roof mesh and guardrails as described in Appendix 3. If any areas of the roof, such as box gutters, are not provided with mesh, other means of fall prevention should be installed.
2. Install an access tower. The access tower should be located as close as possible to the load position for the first pack of sheets. (See Figure 29).

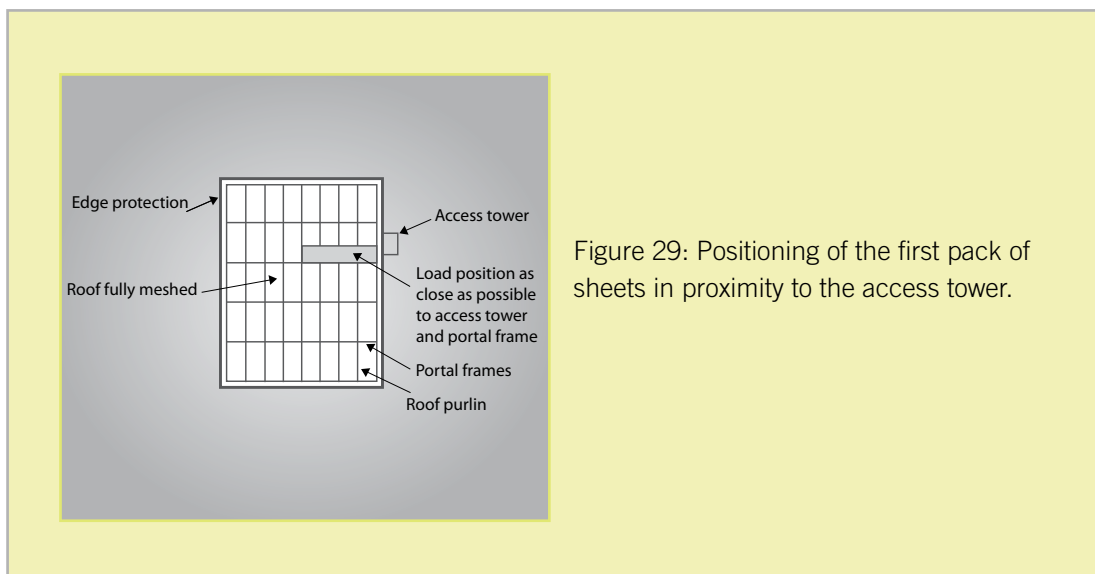

Figure 29: Positioning of the first pack of sheets in proximity to the access tower.

Courtesy of WorkSafe Victoria, Code of Practice – No. 28 – Prevention of Falls in General Construction, 31 March 2004.¹⁸

3. Load the first pack of sheets as close as possible to the access tower.

If the crane operator needs help from a worker or a person on the ridgeline in order to control the swing of the load, this person may gain access to the ridgeline by walking up the main rafter of the portal frame. This may occur only after the roof mesh has been installed. Never gain access across the roof by 'purlin hopping' from one purlin to the next.

4. Load each subsequent pack of sheets as close as possible to a portal frame. Where the pitch of the roof is not greater than 15 degrees, access between packs of sheets may be provided along the eave purlin using the guardrail as a support to maintain balance. (See Figure 30) The eave purlin is **not** to be used for general access around the roof.

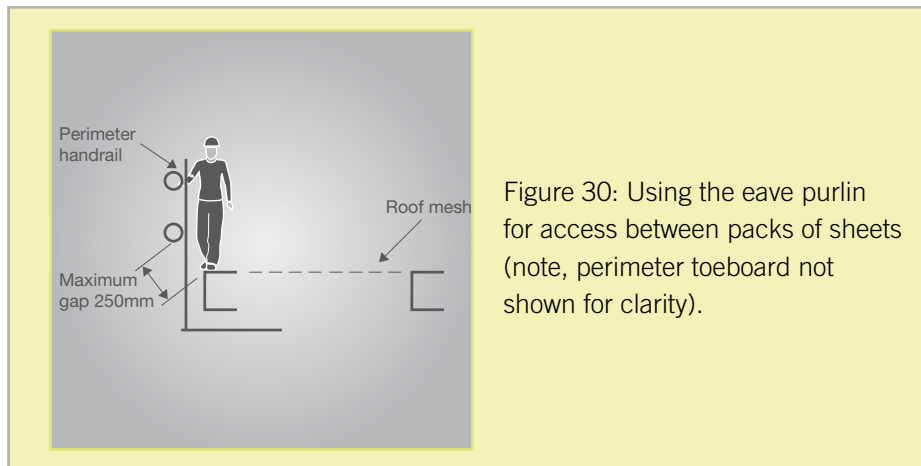

Figure 30: Using the eave purlin for access between packs of sheets (note, perimeter toeboard not shown for clarity).

Courtesy of WorkSafe Victoria, Code of Practice – No. 28 – Prevention of Falls in General Construction, 31 March 2004.¹⁹

5. Persons with control of the work should ensure that the roof sheets are laid out and fixed consecutively to provide a progressive working platform for the roof workers. To accommodate the laying of insulation, a gap may need to be left between roof sheets. Where, in order to complete the roof fixing procedure, workers are required to cross this gap by stepping onto the purlin, then the spacing between sheets should be minimised.

Perimeter guardrails

The installation of guardrailing should include the following:

- > toeboards or mesh infill to prevent tools, materials and debris falling from the roof, unless a 'No Go Zone' is established below the area where roofing works are being carried out and the slope of the roof is less than 15 degrees
- > an additional mid-rail to ensure the nominal clear distance between rails does not exceed 450mm, and
- > a third rail or in-fill panel where the distance, through which a person may fall, between the work surface and the mid-rail exceeds 250mm.

Roof access

The person in control of construction work should ensure that access from the ground to the actual work area is as safe as possible and without risk to health.

When assessing access requirements, persons in control should take into account the tools and equipment the roof worker may be required to carry to and from the work site.

Where temporary ladders are used for access, it should be ensured that:

- > the ladders are secured against displacement at the top and are provided with non-slip feet
- > workers using the ladder have a safe place to stand when alighting from the ladder
- > the stiles of the ladder extend at least 900mm above the stepping-off point, and

¹⁹ For further information and future updates, please access www.worksafe.vic.gov.au



- > metal or wire bound ladders are not used in the vicinity of electrified powerlines.

Where access is via a permanently installed ladder, the ladder and any associated platforms and walkways should comply with AS 1657 or most recent equivalent.

For new roof installations or where extensive repair or replacement of existing roofs is planned, it is recommended that where:

- > the height of the eaves is between 6 and 15 metres above the ground, a ladder access tower be provided, and
- > where the height of the eaves exceeds 15 metres, a personnel and materials hoist be provided as well as a ladder access tower.

Fragile and brittle roofs

If work on or from a fragile or brittle roof is required, the person with control of the construction work should ensure that the precautions recommended in this section are adopted.

Roofs should be assumed to be covered with a brittle or fragile material unless they are specifically identified as metal and in sound condition. Brittle or fragile roofing material can include roofing made of asbestos cement roof sheets, cellulose cement roof sheets, glass, fibreglass, acrylic or other similar synthetic moulded or fabricated material used to sheath a roof or contained in a roof.

Where a roof or part of a roof covering comprises fragile or brittle material, the person in control of construction work should ensure that warning signs are displayed at all points of access to any work area where fragile material is present, and are securely fixed in positions where they will be clearly visible to persons accessing the work area.

Where it is necessary for work to be carried out on a roof containing fragile materials, the person in control should ensure that the underside of the roof is inspected to determine the extent of fragile roof material, the existence of any safety mesh and the structural soundness of the roof and any safety mesh and its fixings.

To enable work to be carried out safely on or adjacent to any part of a roof sheathed in brittle material, the person in control of construction work should ensure that:

- > temporary walkways at least 450mm wide are provided, with edge protection, as a means of access to and egress from any work area where permanent walkways are not provided
- > where the slope of the roof exceeds 1 to 6, cleats should be fixed to the top side of the walkway planks, and the walkway should be adequately secured
- > temporary roof ladders are provided if the roof is steeply sloping (i.e. in excess of 35 degrees); these should be used in conjunction with an individual fall-arrest device.

Working safely on roofs – things to consider

1. Is there safe access to roof areas?

Where there is no permanent access to roof areas provide properly constructed temporary access.

Portable industrial-grade ladders with a load rating of at least 120 kg, secured against movement, pitched



at about 75 degrees (4 to 1) and extending at least 900mm above the stepping-off point may be suitable for minor works. For major roofing work, provide a scaffold access tower, preferably one with temporary stairways. Where more than two workers are likely to access the roof at the same time, provide an access tower that is at least medium duty. Provide a heavy-duty access tower where more than five workers are likely to be on the roof. Never allow workers to use barrow hoists to gain access to the roof. Workers should only use EWPs to gain access to roofs where the specific conditions of AS 2550.10 or most recent equivalent can be met.

2. Have existing roofs been thoroughly checked?

Before commencing work on an existing roof, make sure it has been thoroughly inspected to determine its strength. Check the condition of roof trusses, rafters, purlins and roof battens. Identify all areas of fragile roofing such as cement sheeting and fibreglass skylights. Check the fixing and strength of safety mesh, paying particular attention to any signs of heavy corrosion. Strengthen any suspect areas of roof support with temporary props or similar.

3. Are workers protected from falling off roof edges?

A fall from height is the single most serious risk associated with roof work. Where a scaffold has been provided for construction of the walls or guttering, leave it in place until the roof work is complete. Where this is not possible, use a temporary guardrailing system. There are proprietary guardrailing systems available which are suitable for a wide range of roofing situations. For the rare occasions when guardrailing is not practical, consider using other measures such as safety line systems, including travel restraint systems and fall-arrest systems. Make sure that any safety line system is securely anchored and is set up so that inertia reel lines or other types of lanyards cannot be severed on sharp edges. Also make sure that the lines can be used without creating the 'pendulum effect' in the event of a worker falling.

4. Are workers protected from falling from incomplete roofs?

For metal deck roofing, the best way to protect roof workers from falling over leading edges is to cover the entire roof area with safety mesh before the roof is laid. This also provides ongoing protection for future roof maintenance and repair work. The same applies for roof tiling work, and the close spacing of roof battens is another safeguard to assist in the protection of workers from leading edge falls.

5. Are workers protected from falling through skylights and penetrations?

Skylights that are not protected with safety mesh and penetrations left for purpose such as the installation of air-conditioning, can be a danger to roof workers. Securely cover them or fix temporary guardrailing around them.

6. Are people protected from the dangers of falling material?

Isolate the area below roof work wherever there is any danger of people being struck by falling material, debris or tools. Also isolate areas under roof edges unless toeboards are fixed to temporary guardrailing to contain all material, debris and loose tools.

7. Do roof workers have appropriate footwear?

Roof workers need protective footwear that gives them a non-slip and flexible grip on the roof surface.



APPENDIX 5 - GUARDING OF HOLES AND OPENINGS

Holes, penetrations and openings in roofs and other structures should be made safe immediately after they are formed.

Holes or openings in concrete floors should, where reasonably practicable, be guarded with embedded wire mesh and covered with material that is strong enough to prevent objects or persons falling through.

Holes or openings in any other type of (non-concrete) floor should be covered with material that is strong enough to prevent objects or persons falling through and be securely fixed to the floor.

Holes or openings covered with wire mesh should not be used as a work platform.

When installing services, only the part of the wire mesh that allows access for installation should be removed, and the cover should be modified to fit around the installed service.

All covers should be securely fixed and marked clearly with the words 'Danger - Hole Beneath'

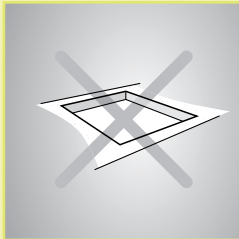

Figure 31:
Unprotected holes are a severe hazard and should be covered.

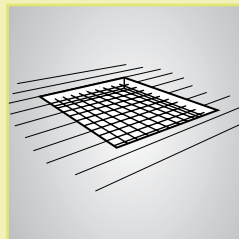

Figure 32: 4 mm mesh embedded in the concrete floor. The hole should also be covered to prevent things falling through.

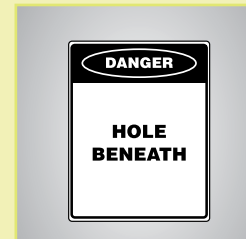

Figure 33: Example of the type of danger sign to be affixed to the hole cover.

Courtesy of the Commission for Occupational Safety and Health, Western Australia, Code of Practice: Prevention of Falls at Workplaces, 2004²⁰



APPENDIX 6 - FALL-ARREST SYSTEMS

Individual fall-arrest systems can be used to arrest falls where workers are required to carry out their work near an unprotected edge. However, they may only be used as the sole means of risk control if it is not reasonably practicable to use measures higher in the hierarchy of control.

Safety harnesses and lanyards can also be used as travel restraint systems to prevent workers moving from safe to unsafe areas on roofs.

Preparation

Compliance with published technical standards

Fall-arrest systems should comply with series AS/NZS 1891 or most recent equivalent.

Provide adequate training

Persons in control of construction work must ensure that any worker required to use a fall-arrest system is properly trained in its use.

Installation and use

Limit free fall distance

Fall-arrest systems, incorporating a lanyard, should be installed so that the maximum distance a person would free fall before the fall-arrest system takes effect is 2 metres. There should be sufficient distance between the work surface and any surface below to enable the system, including the action of any shock absorber to fully deploy. Personal energy absorbers complying with AS/NZS 1891 or most recent equivalent should be used in conjunction with the lanyard.

Lanyards should **not** be used in conjunction with inertia reels as this can result in an excessive amount of free fall prior to the fall being arrested.

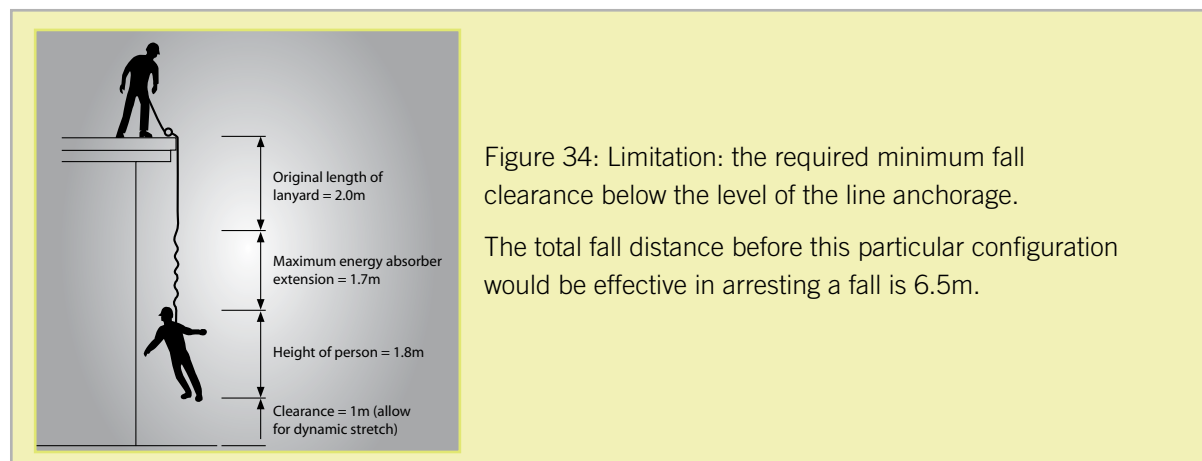



Use full body arrest harnesses

Full body fall-arrest harnesses should be worn. Waist-type belts should not be used as injuries can result when the wearer's fall is arrested. The harness connection point to the fall-arrest line should be made at the top dorsal position. An alternative attachment position is when a line and rope-grab device is used on steeply sloping roofs and the user needs to manually operate the device by having the device in front. In these circumstances the user can make the connection onto a front connection point as recommended by the manufacturer.

Maintain minimum of slack in fall-arrest line

There should be a minimum of slack in the fall-arrest line between the user and the attachment. The anchorage point should be as high as the equipment permits. Never work above the anchor point, as this will increase the free fall distance in the event of a fall, resulting in higher forces on the body and greater likelihood of the arrest line snagging on obstructions

Use inertia reels correctly

When considering the use of inertia reels, bear in mind that they might not be effective in certain situations. For example, if a worker falls down the inclined surface of a steeply pitched roof, the inertia reel line may keep extending from the reel – it may not lock.

Inertia reels should not be used as working supports by locking the system and allowing it to support the user during normal work. They are not designed for continuous support.

Vertical and self-retracting anchorage lines can be used as a risk control measure in connection with work performed from boatswains' chairs and ladders. Where such lines are used, not more than one person should be attached to any one line.

Use compatible components

Fall-arrest systems and safety harnesses should only be used with the individual manufacturer's components known to be compatible. The use of non-compatible components may lead to 'roll-out' with some hook/karabiner configurations, resulting in injury or death to the user. The hazard cannot always be avoided by using components produced by the same manufacturer under the one brand name. If unsure whether components of a fall-arrest system are compatible, contact the manufacturer for further information.

Snap hooks should be of the double action type, requiring at least two consecutive deliberate actions to open. Snap hooks should not be connected to each other as this could prevent the safe operation of the snap hook (for example, roll-out may occur). Some double action hooks are susceptible to roll-out. Screw gate karabiners or hex nut connectors may sometimes be appropriate. Further guidance is provided in AS/NZS 1891 or most recent equivalent.

Ensure prompt rescue in event of fall

It is imperative that the rescue of a worker who is suspended in a full body harness should occur promptly. Suspension trauma is a condition whereby a person suspended in a harness in a substantially



upright position may experience blood pooling in the legs. Depending on the susceptibility of the individual, this may lead to loss of consciousness, renal failure and eventually death.

To enable the worker to be removed from the suspended position as quickly as possible, employers should consider having a pre-rigged retrieval system in place and ensure that workers using safety harnesses do not work alone.

Damage to lines and lanyards

Preventing failure of the fall-arrest line

Fall-arrest systems can be used to arrest falls where workers are required to carry out their work near an unprotected edge. However, when fall-arrest anchorages are located lower than head height or the system user is situated at a horizontal distance away from the anchorage, the fall-arrest line is likely to make abrupt contact with an edge if the worker falls through or from the perimeter of the structure, as shown below. This could lead to failure of the fall-arrest line. This also applies to lanyard systems. Precautions should be taken to ensure that the lanyard will not be damaged or fail if it comes into contact with any edge during a fall.

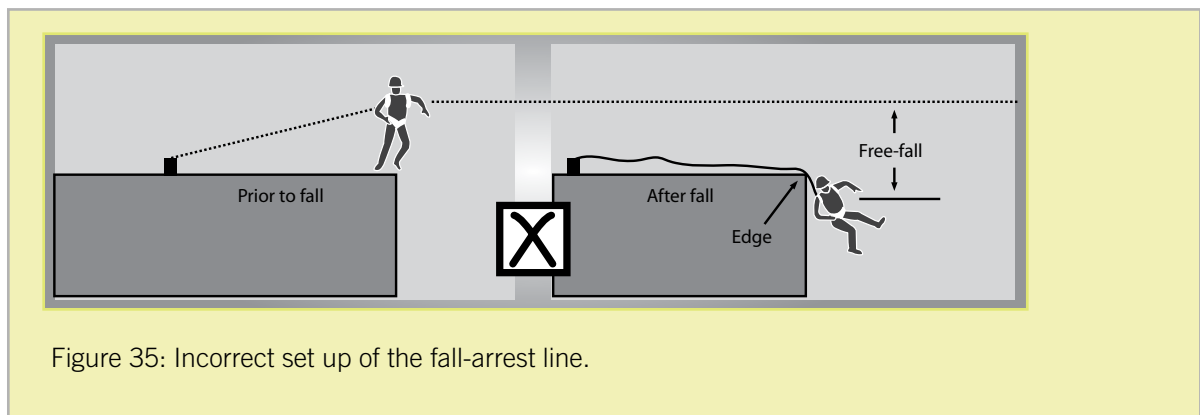

Figure 35: Incorrect set up of the fall-arrest line.

Courtesy of WorkSafe Victoria, Code of Practice – No. 28 – Prevention of Falls in General Construction, 31 March 2004.²¹

Damage or failure occurs because contact with an edge (such as a steel I-beam or brick parapet) reduces the breaking strength of the inertia reel line. In addition, the shock loading is transferred to the snagging point of the line and not to the internal energy absorber of the inertia reel.

In the event of a fall, the inertia reel line should not contact an obstruction or edge, unless the manufacturer can verify that such contact will not impair the safe use of the inertia reel. It is important that the verification applies to the specific type of edge involved in the work process.

Positioning the inertia reel anchor points

Inertia reels should be anchored above head height to prevent the line making contact with an obstruction and to limit the free fall distance to that recommended by the designer/manufacturer. The user should

²¹ For further information and future updates, please access www.worksafe.vic.gov.au



work within an arc below the inertia reel, as illustrated below.

Note: provision of an anchorage point above head height is difficult to achieve in demolition operations. Other control measures will therefore need to be provided.

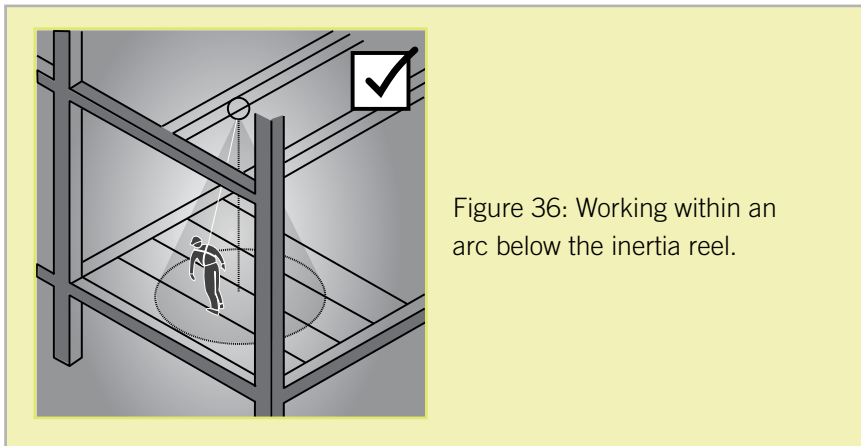

Courtesy of WorkSafe Victoria, Code of Practice – No. 28 – Prevention of Falls in General Construction, 31 March 2004.²²

Hazards with individual fall-arrest systems

Pendulum effect

If a person using an individual fall-arrest system falls, the system may act as a pendulum, and in some situations the user may swing onto the ground (which is called ‘swing down’) or swing back onto the building or structure (which is called ‘swing back’).

Swing down

Swing down can occur if the fall-arrest line slides back along the perimeter edge of the roof until it is vertical. When this happens, the person may hit the ground, or the arrest line may break as a result of its contact with the edge of the roof.

Measures to address the hazard of ‘swing down’ include:

- > the installation of guardrails
- > placing the anchorage point at a right angle to the position of the line at the perimeter edge (for example, by using a mobile anchorage), and
- > the installation of a second anchorage point and belay devices (intermediate anchorages).

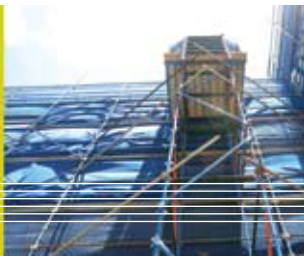

Figure 37: During 'swing down' the length of the lanyard and positioning of the anchor allow contact with the ground.

Swing back

With 'swing back' the user swings back into the building structure and collides with any obstructions on the path of this swing.

If there is any risk of 'swing back', then the use of an individual fall-arrest system should be reassessed.

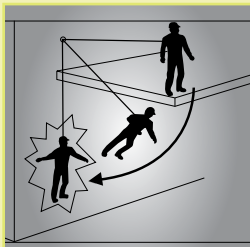

Figure 38: During 'swing back' the worker may hit the structure.

Figures 37 and 38 are courtesy of WorkSafe Victoria, Code of Practice – No. 28 – Prevention of Falls in General Construction, 31 March 2004.²³

Inspection of fall-arrest systems

It is essential that all equipment is correctly maintained with inspections and examinations of all components by a competent person at regular intervals.

Inspection of anchorages

Persons with control of construction work should ensure that a permanently fixed anchorage is inspected by a competent person, and it is regularly inspected at not less than six month intervals if it is permanently fixed and in regular use.

²³ For further information and future updates, please access www.worksafe.vic.gov.au



If a permanently fixed anchorage is not in regular use, it should be inspected before it is used.

When the competent person doing an inspection assesses the anchorage is impaired, the employer should ensure that:

- > the anchorage is not used and is tagged to indicate it is not to be used, and
- > the repaired anchorage is not used until it is inspected by a competent person who can confirm it is safe to use.

All anchorages should be visually checked prior to use.

Inspections for faults and condition

Checklists for inspections to detect any equipment faults and assess the condition of fall-arrest belts, lanyards and harnesses can be found in equipment manufacturers' documentation.

Inspections after a fall-arrest

A fall-arrest system that has arrested a fall should be checked by a competent person following the fall and not returned to service until it has been verified as being fully serviceable.



APPENDIX 7 – COMMON FALL HAZARDS – THINGS TO CONSIDER

The following is a list of some of the more common issues that should be taken into consideration when identifying fall hazards in the workplace.

- > **Surfaces:**
 - the stability, fragility or brittleness
 - the ability to slip (e.g. where surfaces are wet, polished, glazed or oily in the case of new steelwork)
 - the safe movement of workers where surfaces change
 - the strength or capacity to support loads, and
 - the slope of work surfaces
- > **levels** - where levels change and workers may be exposed to a fall from one level to another
- > **structures** - the stability of temporary or permanent structures
- > **the ground** - the evenness and stability of ground for safe support of scaffolding or a work platform
- > **the working area** - whether it is crowded or cluttered
- > **scaffolding** - check for platform fully decked, bracing, tying, guardrails, access
- > **edges** - edge protection for open edges of floors, working platforms, walkways, walls or roofs
- > **penetrations, openings and holes** - which will require guarding (similarly **unguarded shafts** and **excavations**)
- > **proximity of workers to unsafe areas:**
 - where loads are placed on elevated work areas
 - when objects are below a work area, such as reo bars and star pickets
 - where work is to be carried out above workers (e.g. potential hazard from falling objects), and
 - power lines near working areas
- > **movement of plant or equipment**
- > **access to, egress from and movement around the working area** (checking for obstructions)
- > **multiple contractors are working in the same area**
- > **manual handling** - checking safe work practices for carrying awkward material, such as plaster boards and roof sheeting, which may be caught by the wind
- > **vision is impaired** - or restricted by the use of goggles, face shields, respirators or other devices, or there is reflective glare off surfaces
- > **lighting** - should be adequate for the task
- > **weather conditions** - when heavy rain, dew, extreme heat or cold or wind are present

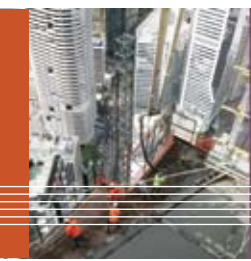

- > **footwear and clothing** - suitability for conditions
- > **ladders** - where and how they are being used.



APPENDIX 8 – SCAFFOLDING – SAFETY CONSIDERATIONS

Safety requirements and other considerations for scaffolds include:

- > scaffolding should conform to the AS/NZS 1576 series or their most recent equivalents.
- > all scaffolding must be erected, altered and dismantled by a competent person
- > if a person could fall 4 or more metres from a scaffold, that scaffold must be erected, altered and dismantled by the holder of a certificate of competency for the appropriate class of scaffolding
- > a person must not alter scaffolding without authority from the person with control of the construction project
- > scaffold platforms should be a minimum of 450mm wide
- > modular scaffolds should be of the same type, not mixed components. Mixed components from different manufacturers have resulted in scaffold incompatibilities and failures, posing significant risks to persons using the scaffolding
- > mobile tower frame scaffolds can be used to provide safe working platforms
- > brick guards or mesh panels should be fitted to working platforms where bricks are being stacked and laid
- > the maximum load capacity of a scaffold must never be exceeded
- > a scaffold that is incomplete and left unattended should have danger tags and warning signs attached at locations to prevent use, and access points to the incomplete scaffold blocked off
- > all long term scaffolds, regardless of height, should be checked regularly for structural integrity by a competent person
- > scaffold exceeding 4 metres in height should be inspected and tagged by a competent person before use, after any alteration or repair, and at intervals of not greater than 30 days
- > additional inspections should be carried out by a competent person following an occurrence such as a severe storm or earthquake
- > safe access to and egress from the scaffold should be provided, and
- > edge protection (guardrails and toeboards) should be provided at every open edge of a scaffold working platform. Meshing should be installed over access and egress points.



APPENDIX 9 - GUARDRAILS – SAFETY CONSIDERATIONS

The safety requirements for guardrails include:

- > every open edge of a stair, landing, platform or shaft should be protected to prevent a person falling
- > the guardrail system should be constructed to withstand a force of 0.55 kN (approximately equivalent to 55 kg) applied at any point. Where edge protection is used on roofs with pitches exceeding 15 degrees from the horizontal, the edge protection should be able to withstand the added impact forces
- > top-rails should be between 900mm and 1100mm above the working surface
- > midrails and toeboards should be provided. However, wire mesh infill panels incorporating a toeboard may be used instead of the mid-rail
- > a bottom rail above the toeboard should be provided for more severe roof slopes. Both a mid-rail and infill mesh panel will assist in preventing persons and objects from falling through
- > guardrails should comply with AS 1657 and/or AS/NZS 4576 or their most recent equivalent
- > if access points are required for equipment (for example, a hoist), they should be protected with gates, safety chains or other means to prevent a person from falling through, and
- > where guardrail systems are intended to be used in conjunction with steel structures or tilt-up construction, designers and builders should plan for the guardrails and fixings to be attached to the panels prior to the structures being raised from the ground.



APPENDIX 10 – PUBLICATIONS REFERENCED

The following is a list of publications and sources of information referenced in this Code.

Australian Standards and Australian/New Zealand Standards

- | | |
|---------------------------|--|
| AS 1319 | Safety Signs for the Occupational Environment |
| AS 1418.17 | Cranes (including hoists and winches) – Design and construction of workboxes |
| AS/NZS 1576 | Scaffolding series |
| AS 1577 | Scaffold Planks |
| AS 1657 | Fixed Platforms, Walkways, Stairways and Ladders — Design, Construction and Installation |
| AS/NZS 1891 series | Industrial Fall-arrest Systems and Devices |
| AS/NZS 1892 series | Portable Ladders |
| AS 2550.1 | Cranes, Hoists and Winches — Safe Use — General Requirements |
| AS 2550.10 | Cranes, Hoists and Winches — Safe Use — Mobile Elevating Work Platforms |
| AS 2550.16 | Cranes — Safe Use — Mast Climbing Work Platforms |
| AS/NZS 4389 | Safety Mesh |
| AS/NZS 4488 series | Industrial Rope Access Systems |
| AS/NZS 4576 | Guidelines for Scaffolding |
| AS/NZS 4994 series | Temporary roof edge protection for housing and residential buildings |

National Standard for Construction Work [NOHSC: 1016 (2005)]

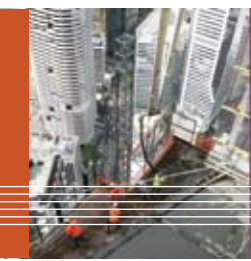

10. LIST OF FIGURES

Figure 1	Hazard: Plasterer's stilts.	23
Figure 2	A splithead trestle scaffold.	23
Figure 3	Hazard: Standing above second tread of step ladder.	24
Figure 4	A step platform.	24
Figure 5	A ladder-bracket scaffold.	26
Figure 6	Guardrails protecting an open penetration through the slab.	29
Figure 7	A perimeter scaffold.	31
Figure 8	A mobile scaffold.	31
Figure 9	Correctly set up trestle scaffold.	33
Figure 10	Boom-type elevating work platform.	34
Figure 11	Scissor-lift elevating work platform.	34
Figure 12	A typical mast climbing work platform.	35
Figure 13	An example of a perimeter screen.	36
Figure 14	Temporary guardrailing on a high-rise building.	37
Figure 15	Guardrails for roof work.	38
Figure 16	Travel restraint system options.	41
Figure 17	Ways of securing a ladder.	43
Figure 18	Pole straps used with portable ladders.	44
Figure 19	Unsafe ladder use.	44
Figure 20	Acceptable ladder use.	44
Figure 21	Signage for a 'No Go' area.	45
Figure 22	Fall prevention for trenching works – steel mesh covers over trench shields.	48
Figure 23	An example of trench shoring.	48
Figure 24	An unguarded trench.	48
Figure 25	Installing safety mesh.	55
Figure 26	Fixing wire mesh to purlins.	55
Figure 27	Overlapping adjacent runs of wire mesh.	56
Figure 28	Joining longitudinal wires of safety mesh.	56
Figure 29	Installing roof sheets on a portal frame.	57
Figure 30	Using the eave purlin for access between packs of sheets.	58



Figure 31	Unprotected holes.	61
Figure 32	Holes covered by mesh.	61
Figure 33	Danger signs for covered holes.	61
Figure 34	Total fall distance for a fall-arrest system.	62
Figure 35	Incorrect set up of the fall-arrest line.	64
Figure 36	Working within an arc below the inertia reel.	65
Figure 37	Swing down hazard for a fall-arrest system.	66
Figure 38	Swing back hazard for a fall-arrest system.	66



11. DEFINITIONS

For the purpose of this Code:

'Administrative control' is a system of work or safe work method that helps to reduce a worker's exposure to a fall hazard. Administrative controls are often used to support other fall prevention measures.

'Anchorage' means a secure point for attaching a lanyard, lifeline or other component of a travel restraint system or fall-arrest system. Anchorages require specific load and impact capacities for their intended use.

'Arrest force' is the force imposed upon the worker and the anchorage point the moment the fall-arrest system stops the fall.

'Australian Standard', 'Australian/New Zealand Standard', 'AS' and 'AS/NZS' refer to standards developed and published by Standards Australia International. These are voluntary technical and commercial standards.

'Certificate of competency' is referred to as a license for high risk work in this document.

'Client' means any person who commissions design work for a structure.

'Competent person' means a person who has acquired through training, qualification or experience (or a combination of these) the knowledge and skills enabling that person to safely perform a specified task.

'Construction project' means a project involving construction work, and includes the design, preparation, and planning.

'Construction site' means a place at which construction work is undertaken, and any other area in the vicinity where plant or other material used or to be used in connection with the construction work is located or kept during the construction work. It does not include a place where elements are manufactured 'off site' or where construction material is stored as stock for sale or for hire.

'Construction work' means any work on or in the vicinity of a construction site carried out in connection with the construction, alteration, conversion, fitting out, commissioning, renovation, repair, maintenance, de-commissioning, demolition or dismantling of any structure, and includes:

- > the demolition or dismantling of a structure, or part of a structure, and the removal from the construction site of any product or waste resulting from the demolition or dismantling
- > the assembly of prefabricated elements to form a structure or the disassembly of prefabricated elements, which, immediately before such disassembly, formed a structure
- > any work in connection with any excavation, landscaping, preparatory work, or site preparation carried out for the purpose of any work referred to in this definition, and
- > any work referred to in this definition carried out under water, including work on buoys, obstructions to navigation, rafts, ships, and wrecks

but does not include the exploration for or extraction of mineral resources or preparatory work relating to the extraction carried out at a place where such exploration or extraction is carried out.



‘Design’ in relation to any structure means any drawing, design detail, scope of works document or specification relating to the structure.

‘Designer’ means a person whose profession, trade or business involves them in:

- > preparing designs for structures, including variations to a plan or changes to a structure, or
- > arranging for people under their control to prepare designs for structures.

‘Elevating work platform’ (EWP) means a telescoping, scissor or articulating device, or any combination of these, that is used to position personnel, material or equipment at an elevated work area.

‘Fall-arrest harness’ means an assembly of interconnected shoulder and leg straps, with or without a body belt, which is designed to distribute forces to minimise the likelihood of injury resulting from an arrested fall, and to prevent the wearer from falling out of the assembly of straps. It consists of a full body harness (parachute type) together with associated components such as a lanyard and personal energy absorber.

‘Fall-arrest static line’ means a horizontal, near-horizontal or vertical line (for a ladder fall-arrest device) to which a lanyard may be attached and which is designed to arrest a free fall. Each end of the line is connected to a fixed anchorage point. The line may be made of metal tubes, metal rods, steel wire rope, synthetic webbing or synthetic rope.

‘Falling’ is a reference to a person falling, and includes a person falling from, through or into a place or thing.

‘Fall injury minimisation system’ means equipment, material or a combination of equipment and material that is designed to prevent, or reduce the severity of injury to a person if a fall from one level to another does occur.

‘Free fall’ is any fall or part of a fall where the person falling is under the unrestrained influence of gravity over any fall distance, either vertically or on a slope on which it is not possible to walk without the assistance of a handrail or hand line.

‘Formwork’ means the surface, supports and framing used to define the shape of concrete until the concrete is self-supporting. It includes the forms on which the concrete is poured, the supports used to withstand the loads imposed by the forms and the concrete, the bracing that may be added to ensure stability, and the footings. The formwork structure is called the formwork assembly. Parts of the formwork assembly are also known as falsework. Examples of formwork include prefabricated systems such as slip forms, table forms and jump forms.

‘Guardrailing’ is a protective barrier attached directly to a house, building, scaffold or other structure by posts.

‘Hazard’ is, with regard to falls from a height, any situation where there is potential for someone to fall from one level to another.



'Individual fall-arrest system' is a system designed to arrest a fall and consists of some or all of the following:

anchorage	retractable lifeline
lifeline	rope grabs
inertia reel	wire grabs
lanyard	rail system
shock absorbers	harness.

'Industrial rope access system' means a work positioning system used for gaining access to and working at a work face, usually by means of vertically suspended ropes.

'Inertia reel' (also known as a self-retracting lanyard or fall-arrest block) — is a mechanical device that arrests a fall by locking onto a dropline and at the same time allows freedom of movement.

'Ladder fall-arrest device' means a device that travels along a fall-arrest static line, parallel to a ladder, and locks onto the line when loaded. The device can be loaded only in the direction of the line.

'Lanyard' means a line used, usually as part of a lanyard assembly, to connect a harness to an anchorage point or static line.

'Lanyard assembly' means an assembly consisting of a lanyard and a personal energy absorber. The lanyard assembly should be as short as reasonably practicable, with a working length of not more than 2 metres.

'Likelihood' means the probability that an event will occur.

'National Standard for Construction Work' or **'National Standard'** means the National Standard for Construction Work [NOHSC: 1016(2005)], declared by the National Occupational Health and Safety Commission, and as amended.

'Passive fall prevention device' means material or equipment, or a combination of material and equipment, that is designed to prevent a person from falling, and which, after initial installation, requires ongoing inspections to ensure its integrity but does not require ongoing adjustment, alteration or operation to perform its function. Examples include scaffolding and perimeter guardrailing.

'Person with control' means:

- > a person with control over the workplace, or
- > a person with control over work.

'Person with control over a workplace' means a person who has management or control of a workplace.

Note: An owner of a workplace and an occupier of a workplace can be persons with control of workplaces, to the extent that they have management or control of the workplace. An employer may also be the owner or occupier of a workplace.

'Person with control of work' means a person who has management or control over work.

Note: An employer, owner, manager of a labour hire company, franchisee and franchisor, will be a person with control of work and a self-employed person, such as a sub-contractor, can be persons with control



of work. Each is considered a person with control of work to the extent that they have management or control of the work.

'Personal energy absorber' (or deceleration device) means a device, used with a fall-arrest harness and lanyard, which reduces the deceleration force imposed when a fall is suddenly arrested, and correspondingly reduces the loadings on the anchorage and the person's body. The energy absorber may either be a separate item or manufactured as part of the lanyard.

'Reasonably practicable' means what can be done and which is reasonable in the circumstances taking account of:

- > the probability (likelihood) of the hazard or risk occurring
- > the degree of harm arising from the hazard or risk
- > the availability and suitability of ways to remove or mitigate the hazard or risk
- > the state of knowledge about the hazard or risk and ways it may be removed or mitigated, and
- > the cost of removing or mitigating the hazard or risk.

'Restraint line' is the line securing workers to a point of anchorage and is used to prevent a person from reaching a point from which they could fall.

'Risk' means the likelihood of a hazard causing harm to a person.

'Safe Work Method Statement' (SWMS) means a statement that:

- > identifies a work activity assessed as having a safety risk or risks
- > states the safety risk or risks
- > describes the control measures that will be applied to the work activity
- > describes how safety measures will be implemented, and
- > includes a description of the equipment used in the work, the qualifications of the personnel doing the work and the training required to do the work safely.

'Scaffold' is a temporary structure specifically erected to support one or more access platforms or working platforms.

'Solid construction' means a constructed supporting surface that:

- > is structurally capable of supporting people, material and any other loads intended to be applied to it
- > is provided with protection at its perimeter, around open penetrations and around any other area necessary to prevent persons from falling
- > has an even and readily negotiable surface and gradient, and
- > is provided with a safe means of access and egress.

'Structure' means:

- > any building, steel or reinforced concrete construction, railway line or siding, tramway line, dock, ship, submarine, harbour, inland navigation channel, tunnel, shaft, bridge, viaduct, waterworks, reservoir, pipe or pipeline (whatever it contains or is intended to contain), structural cable, aqueduct, sewer, sewerage works, gasholder, road, airfield, sea defence works, river works, drainage works, earthworks,



constructed lagoon, dam, wall, mast, tower, pylon, underground tank, earth retaining construction, fixed plant, construction designed to preserve or alter any natural feature, and any other similar construction, and

- > any formwork, falsework, scaffold or other construction designed or used to provide support or access during construction work.

‘Total fall distance’ is the total distance a person is likely to fall during both the free and restrained parts of a fall and includes the maximum dynamic extension of all supporting components.

‘Travel restraint system’ means a system in which a harness or belt is attached to one or more lanyards, each attached in turn to a static line or anchorage point, so as to restrict the travelling range of a person wearing the harness or belt and preventing them from reaching a position from which they could fall.

‘Work box’ means a personnel carrying device designed for attachment to a crane for the purpose of providing a working area for persons elevated by and working from the box.

‘Work positioning system’ means any equipment, other than a temporary work platform, which enables a person to be positioned and safely supported at a work location for the duration of that work.